

Cook & Hold Ovens Smoker Ovens

Deluxe Control

300-TH	750-SK
500-TH	1000-SK
750-TH	1200-SK
1000-TH	1750-SK
1200-TH	
1750-TH	



MN-46708-EN

REV.02
1/21

EN



Manufacturer's Information

Copyright

© Copyright 11/20 by Alto-Shaam, Inc.

All rights reserved.

This manual or any portion thereof may not be reproduced or used in any manner whatsoever without the express written permission of Alto-Shaam, Inc.

Trademarks

All trademarks referenced in this documentation are the property of their respective owners.

Manufacturer

Alto-Shaam, Inc.

P.O. Box 450

W164 N9221 Water Street

Menomonee Falls, WI 53052

Original instructions

The content in this manual is written in American English.

Enjoy your Alto-Shaam® Cook & Hold Oven!

Halo Heat® Technology

Cook & Hold Oven

Precise, low-temperature cooking with Halo Heat technology perfected prime rib for decades. Free up time with overnight cooking for corned beef, confit, and even yogurt. Cook your food to perfection and hold for hours without compromising food quality. No fans. No hood needed. Only big flavor and savings.

Smoker Oven

The Alto-Shaam smoker oven can make a big impact on your operation. Use hot or cold smoke to prepare anything from brisket to cheese. Cook your food to perfection, and/or smoke it to perfection, then hold it for hours without compromising food quality.

Extend Your Manufacturer's Warranty

Register

Register your Alto-Shaam appliance online. Registering your appliance ensures prompt service in the event of a warranty claim.

Your personal information will not be shared with any other company.

alto-shaam.com/warranty

Alto-Shaam 24/7 Emergency Repair Service

Call

Call 800-558-8744 to reach our 24-hour emergency service call center for immediate access to local authorized service agencies outside standard business hours. The emergency service access is provided exclusively for Alto-Shaam equipment and is available throughout the United States through Alto-Shaam's toll free number.

Availability

Emergency service access is available seven days a week, including holidays.

This page intentionally left blank.

Manufacturer’s Information	2
Foreword	3
Enjoy your Alto-Shaam® Cook & Hold Oven!	3
Extend Your Manufacturer’s Warranty	3
Alto-Shaam 24/7 Emergency Repair Service	3
Table of Contents	5
Safety	7
The Meaning of Signal Words	7
Safety Precautions.	8
Labels	11
Label Locations	11
Installation	15
Dimension Drawings	15
How to Receive the Appliance	21
How to Unpack the Oven	22
Pre-Installation Checklist	23
Installation Checklist	26
How to Install the Oven.	28
How to Connect the Electrical Wiring	34
How to Install the Drip Tray	37
How to Stack Two Ovens	38
Operation	39
How to Turn On and Turn Off the Oven	39
How to Prepare the Oven for First Use	40
How to View and Set up WiFi Connection.	41
How to Set up an Ethernet Connection	44
How to Use the Door Vents	46
How to Preheat the Oven.	47
How to Cook with Programmed Recipes	48
How to Cook and Hold by Time in Manual Mode	50
Understanding the Probes	53
How to Cook by Probe in Manual Mode	54
How to Hold by Probe.	58
How to Prepare the Smoker Box for Smoking	60
How to Hot Smoke in Manual Mode	61
How to Cold Smoke	65
How to Create a Recipe.	67
How to Modify, Duplicate, or Delete a Recipe	70
How to Load Recipes from a USB Drive.	71

TABLE OF CONTENTS

How to Save Recipes to a USB Drive	73
How to Update Software with a USB Drive	75
How to Change Settings	77
How to View Oven Information	79
How to Download HACCP Data	80
How to Calibrate the Temperature Probe	82
Maintenance	85
Maintenance Schedule	85
How to Clean the Oven.	87
Troubleshooting	89
Error Codes	89
Cheflinc.alto-shaam.com is Not Available on Your Device	90
Cannot Connect to cheflinc.alto-shaam.com	91
The Oven is not Displayed on the Dashboard	92
Unable to Assign Recipes from the Dashboard to Ovens in the Field	93
Warranty	95
Warranty	95
Declaration of Conformity	97

The Meaning of Signal Words

This manual contains signal words where needed. These signal words must be obeyed to reduce the risk of death, personal injury, or equipment damage. The meaning of these signal words is explained below.

**DANGER**

Danger indicates a hazardous situation which, if not avoided, will result in serious injury or death.

**WARNING**

Warning indicates a hazardous situation which, if not avoided, could result in serious injury or death.

**CAUTION**

Caution indicates a hazardous situation which, if not avoided, could result in minor or moderate injury.

NOTICE

Notice indicates a situation which, if not avoided, could result in property damage.



NOTE: Note indicates additional information that is important to a concept or procedure.

Safety Precautions

Before you begin

Read and understand all instructions in this manual.

Electrical precautions

Obey these electrical precautions when using the appliance:

- Connect the appliance to a properly grounded outlet. Do not use the appliance if it is not properly grounded. Consult an electrician if there is any doubt that the outlet used is properly grounded.
 - Keep the cord away from hot surfaces.
 - Do not attempt to service the appliance or its cord and plug.
 - Do not operate the appliance if it has a damaged cord or plug.
 - Do not immerse the cord or plug in water.
 - Do not let the cord hang over the edge of a table or counter.
 - Do not use an extension cord.
-

Usage precautions

Obey these usage precautions when using the appliance:

- Only use this appliance for its intended use of heating or cooking.
 - Always keep liquids, or foods that can become liquid when heated, level and at or below eye level where they can be seen.
 - Always open the appliance door very slowly. Escaping hot vapors or steam can cause serious injury.
 - Use utensils and protective clothing such as dry oven mitts when loading and unloading the appliance.
 - Use caution when using the appliance. Floors adjacent to the appliance may become slippery.
 - Do not cover or block any of the openings of this appliance.
 - Do not cover shelves or any other part of this appliance with metal foil.
 - Do not use this appliance near water such as a sink, in a wet location, near a swimming pool, or similar locations.
-

Maintenance precautions

Obey these maintenance precautions when maintaining the appliance:

- Obey precautions in the manual, on tags, and on labels attached to or shipped with the appliance.
- Only clean the appliance when the oven is disconnected from the power source.
- Do not store the appliance outdoors.
- Do not clean the appliance with metal scouring pads.
- Do not use corrosive chemicals when cleaning the appliance.
- Do not use a hose or water jet to clean the appliance.
- Do not use the appliance cavity for storage.
- Do not leave flammable materials, cooking utensils, or food inside the appliance when it is not in use.

Continued on next page

Continued from previous page

Operator training

All personnel using the appliance must have proper operator training. Before using the appliance:

- Read and understand the operating instructions contained in all the documentation delivered with the appliance.
- Know the location and proper use of all controls.
- Keep this manual and all supplied instructions, diagrams, schematics, parts lists, notices, and labels with the appliance if the appliance is sold or moved to another location.
- Contact Alto-Shaam for additional training if needed.

Operator qualifications

Only trained personnel with the following operator qualifications are permitted to use the appliance:

- Have received proper instruction on how to use the appliance.
- Have demonstrated their ability with commercial kitchens and commercial appliances.

The appliance must not be used by:

- Persons (including children) with reduced physical, sensory or mental capabilities, or lack of experience and knowledge, unless they have been given supervision concerning use of the appliance by person responsible for their safety.
- People impaired by drugs or alcohol.

- Children should be supervised to ensure that they do not play with the appliance.
- Children shall neither clean nor maintain the appliance.

Condition of appliance

Only use the appliance when:

- All controls operate correctly.
- The appliance is installed correctly.
- The appliance is clean.
- The appliance labels are legible.

Servicing the appliance

- Only trained personnel are permitted to service or repair the appliance. Repairs that are not performed by an authorized service partner or trained technician will void the warranty and relieve Alto-Shaam of all liability.
- To prevent serious injury, death or property damage, have the appliance inspected and serviced at least every twelve (12) months by an authorized service partner or trained technician.
- Contact Alto-Shaam for the authorized service partner in your area.

Continued on next page

Continued from previous page

Personal Protective Equipment (PPE)

Wear the following Personal Protective Equipment (PPE) while cleaning the appliance:

- Protective gloves
- Protective clothing
- Eye protection
- Face protection

Use of restraining devices

A restraining device (tether) must be installed to any appliance that is hard-wired and mounted on casters. The tether must:

- Be secured to the building's structure.
- Limit the movement of the appliance so that no stress is transmitted to the electrical conduit.

A connection point for the tether is located on the back of the appliance.



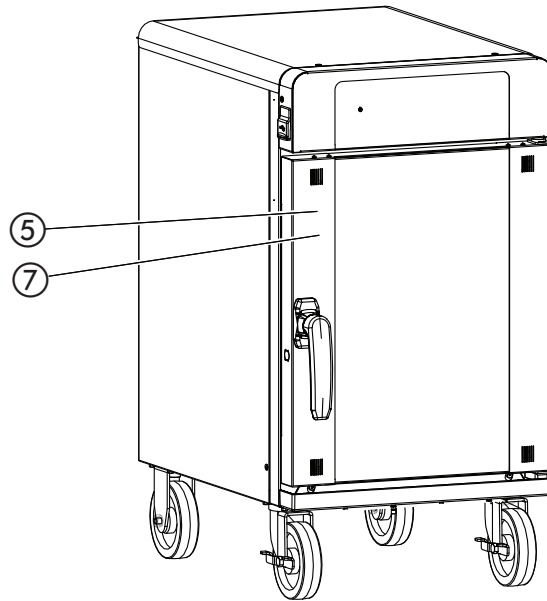
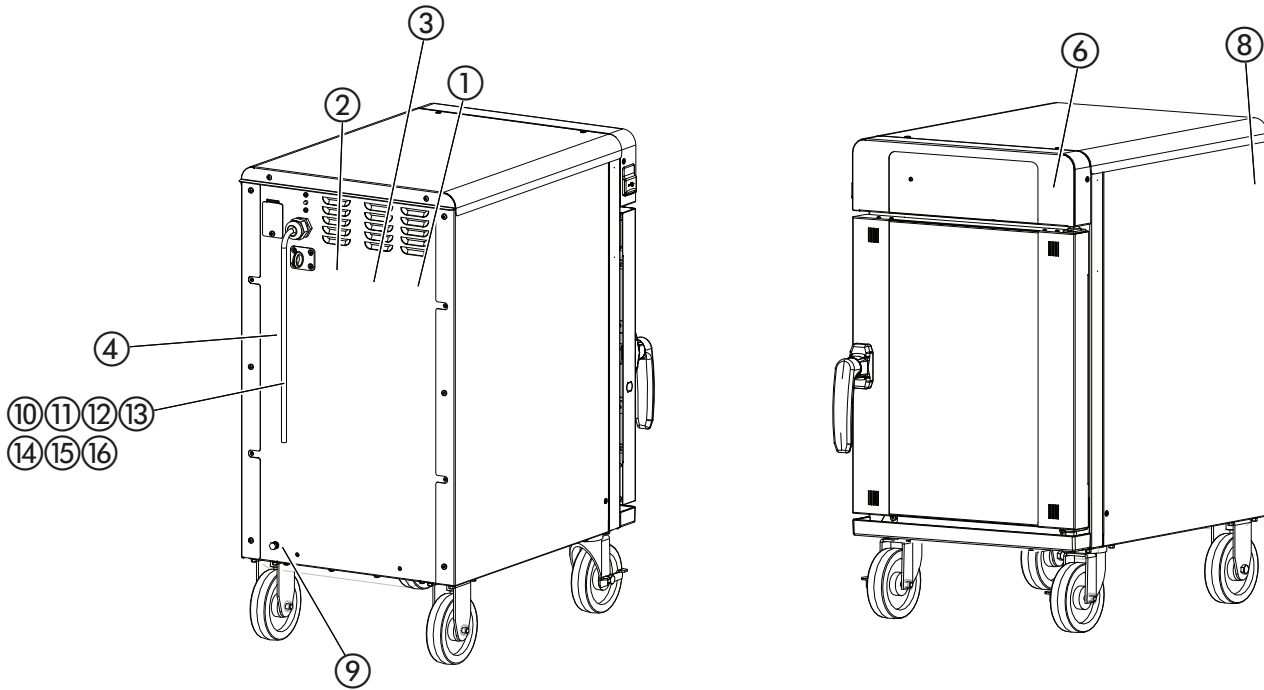

A tether is not supplied by nor available from the manufacturer.





Label Locations

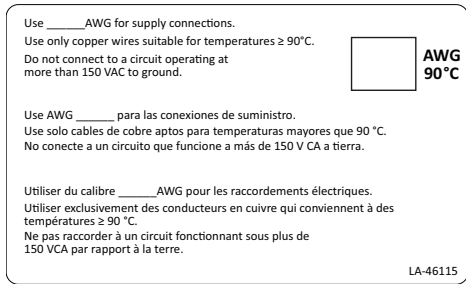
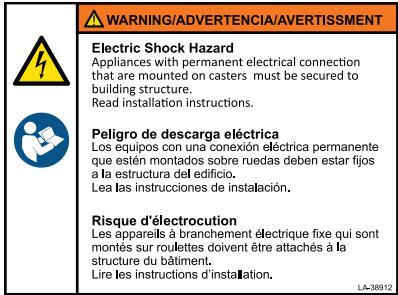
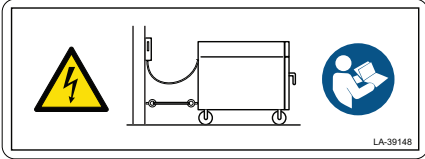

























TH-PHD-008787

LABELS

<p>1</p>	 	<p>WARNING</p> <p>Electric shock hazard</p> <p>To reduce the risk of electric shock, do not remove or open the cover. No user-serviceable parts inside. Refer servicing to qualified personnel. Qualified personnel: Disconnect power before servicing.</p>
<p>2</p>		<p>Note: This label is only used on UL-certified appliances that have 120V to ground wiring.</p> <p>Use _____ AWG for supply connections.</p> <p>Use only copper wires suitable for temperature less than or equal to 90°C.</p> <p>Do not connect to a circuit operating at more than 150 VAC to ground.</p> <p>For use on individual branch circuits only.</p>
<p>3</p>	 	<p>WARNING</p> <p>Electric shock hazard</p> <p>Appliances with permanent electrical connection that are mounted on casters must be secured to building structure. Read installation instructions.</p>
<p>4</p>		<p>Every Alto-Shaam product is precision calibrated prior to release from the factory to ensure accurate temperature control.</p>

5		<p>WARNING Hot surface</p>
6		<p>Made in U.S.A.</p>
7		<p>WARNING Burn hazard Always load liquids, or foods that can become liquid when heated, at an eye level where they can be seen.</p>
8		<p>Security seal</p>
9	 <p>LA-36443-E</p>	<p>Equipotential bonding</p>
10	<p>For use on individual branch circuit only.</p> <p>Utiliser exclusivement sur un propre circuit de dérivation séparé.</p> <p>Nur zum Anschluss an einen Einzelstromkreis geeignet.</p> <p>Para su uso en circuitos derivados individuales solamente.</p> <p>禁止和其他任何电器设备共用供电回路。必须独立分配一路给该设备</p> <p>LA-3088</p>	<p>For use on individual branch circuit only.</p>
11	<p>"WARNING" RISK OF FIRE! "ATTENTION" RISQUE D'INCENDIE !</p> <p>Use a UL Listed grounding type plug rated 240 Volts, 30 Amperes, 1 Phase, 3 wire for single phase units. Plug to be selected and installed only by qualified service personnel.</p> <p>Utilisez une prise homologuée UL conforme pour 240 Volts, 30 Amp res, monophasé, 3 fils pour les appareils monophasés. Les prises ne doivent être sélectionnées et installées que par du personnel de service qualifié.</p> <p>ADVERTENCIA: RIESGO DE INCENDIOS "WARNUNG" BRANDGEFAHR!</p> <p>Utilice un enchufe con toma de tierra de los que se incluyen en las listas de la UL de 240 voltios, 30 amperios, monofásico de 3 hilos para unidades monofásicas. La elección e instalación del enchufe lo realizará exclusivamente personal cualificado del servicio.</p> <p>Verwenden Sie bei Geräten mit Einphasenanschluss einen Schutzkontakt-Stecker 240V/30 A mit 3-adrigem Anschluss und. Die Auswahl und Montage des Steckers darf nur durch einen Fachmann erfolgen.</p> <p>LA-26989</p>	<p>WARNING Fire hazard Use a UL Listed grounding type plug rated 240 Volts, 30 Amperes, 1 Phase, 3 wire for single phase units. Plug to be selected and installed only by qualified service personnel.</p>

<p>12</p>	<table border="1"> <tr> <td data-bbox="261 216 521 348">  <p>WARNING</p> <p>Fire Hazard Use a UL Listed grounding type plug rated 240 Volts, 20 Amperes, 1 Phase, 3 wire for single phase units. Plug to be selected and installed only by qualified service personnel.</p> </td> <td data-bbox="521 216 581 348"> <p>240V, 20A</p> </td> <td data-bbox="581 216 834 348">  <p>ADVERTENCIA/AVERTISSEMENT</p> <p>Peligro de incendio Utilice un enchufe con toma de tierra de los que se incluyen en las listas de la UL de 240 voltios, 20 amperios, monofásico de 3 hilos para unidades monofásicas. La selección e instalación del enchufe la realizará exclusivamente personal cualificado del servicio.</p> <p>Risque d'incendie Utilisez une prise homologuée UL, conforme pour 240 Volts, 20 Amperes, monophasé, 3 fils pour les appareils monophasés. Les prises ne doivent être sélectionnées et installées que par du personnel de service qualifié. L4-4546</p> </td> </tr> </table>	 <p>WARNING</p> <p>Fire Hazard Use a UL Listed grounding type plug rated 240 Volts, 20 Amperes, 1 Phase, 3 wire for single phase units. Plug to be selected and installed only by qualified service personnel.</p>	<p>240V, 20A</p>	 <p>ADVERTENCIA/AVERTISSEMENT</p> <p>Peligro de incendio Utilice un enchufe con toma de tierra de los que se incluyen en las listas de la UL de 240 voltios, 20 amperios, monofásico de 3 hilos para unidades monofásicas. La selección e instalación del enchufe la realizará exclusivamente personal cualificado del servicio.</p> <p>Risque d'incendie Utilisez une prise homologuée UL, conforme pour 240 Volts, 20 Amperes, monophasé, 3 fils pour les appareils monophasés. Les prises ne doivent être sélectionnées et installées que par du personnel de service qualifié. L4-4546</p>	<p>WARNING</p> <p>Fire hazard</p> <p>Use a UL Listed grounding type plug rated 240 Volts, 20 Amperes, 1 Phase, 3 wire for single phase units. Plug to be selected and installed only by qualified service personnel.</p>
 <p>WARNING</p> <p>Fire Hazard Use a UL Listed grounding type plug rated 240 Volts, 20 Amperes, 1 Phase, 3 wire for single phase units. Plug to be selected and installed only by qualified service personnel.</p>	<p>240V, 20A</p>	 <p>ADVERTENCIA/AVERTISSEMENT</p> <p>Peligro de incendio Utilice un enchufe con toma de tierra de los que se incluyen en las listas de la UL de 240 voltios, 20 amperios, monofásico de 3 hilos para unidades monofásicas. La selección e instalación del enchufe la realizará exclusivamente personal cualificado del servicio.</p> <p>Risque d'incendie Utilisez une prise homologuée UL, conforme pour 240 Volts, 20 Amperes, monophasé, 3 fils pour les appareils monophasés. Les prises ne doivent être sélectionnées et installées que par du personnel de service qualifié. L4-4546</p>			
<p>13</p>	<table border="1"> <tr> <td data-bbox="261 459 521 592">  <p>WARNING</p> <p>Fire Hazard Use a UL Listed grounding type plug rated 120 Volts, 30 Amperes, 1 Phase, 3 wire for single phase units. Plug to be selected and installed only by qualified service personnel.</p> </td> <td data-bbox="521 459 581 592"> <p>120V, 30A</p> </td> <td data-bbox="581 459 834 592">  <p>ADVERTENCIA/AVERTISSEMENT</p> <p>Peligro de incendio Utilice un enchufe con toma de tierra de los que se incluyen en las listas de la UL de 120 voltios, 30 amperios, monofásico de 3 hilos para unidades monofásicas. La selección e instalación del enchufe la realizará exclusivamente personal cualificado del servicio.</p> <p>Risque d'incendie Utilisez une prise homologuée UL, conforme pour 120 Volts, 30 Amperes, monophasé, 3 fils pour les appareils monophasés. Les prises ne doivent être sélectionnées et installées que par du personnel de service qualifié. L4-4547</p> </td> </tr> </table>	 <p>WARNING</p> <p>Fire Hazard Use a UL Listed grounding type plug rated 120 Volts, 30 Amperes, 1 Phase, 3 wire for single phase units. Plug to be selected and installed only by qualified service personnel.</p>	<p>120V, 30A</p>	 <p>ADVERTENCIA/AVERTISSEMENT</p> <p>Peligro de incendio Utilice un enchufe con toma de tierra de los que se incluyen en las listas de la UL de 120 voltios, 30 amperios, monofásico de 3 hilos para unidades monofásicas. La selección e instalación del enchufe la realizará exclusivamente personal cualificado del servicio.</p> <p>Risque d'incendie Utilisez une prise homologuée UL, conforme pour 120 Volts, 30 Amperes, monophasé, 3 fils pour les appareils monophasés. Les prises ne doivent être sélectionnées et installées que par du personnel de service qualifié. L4-4547</p>	<p>WARNING</p> <p>Fire hazard</p> <p>Use a UL Listed grounding type plug rated 120 Volts, 30 Amperes, 1 Phase, 3 wire for single phase units. Plug to be selected and installed only by qualified service personnel.</p>
 <p>WARNING</p> <p>Fire Hazard Use a UL Listed grounding type plug rated 120 Volts, 30 Amperes, 1 Phase, 3 wire for single phase units. Plug to be selected and installed only by qualified service personnel.</p>	<p>120V, 30A</p>	 <p>ADVERTENCIA/AVERTISSEMENT</p> <p>Peligro de incendio Utilice un enchufe con toma de tierra de los que se incluyen en las listas de la UL de 120 voltios, 30 amperios, monofásico de 3 hilos para unidades monofásicas. La selección e instalación del enchufe la realizará exclusivamente personal cualificado del servicio.</p> <p>Risque d'incendie Utilisez une prise homologuée UL, conforme pour 120 Volts, 30 Amperes, monophasé, 3 fils pour les appareils monophasés. Les prises ne doivent être sélectionnées et installées que par du personnel de service qualifié. L4-4547</p>			
<p>14</p>	<table border="1"> <tr> <td data-bbox="261 716 521 848">  <p>WARNING</p> <p>Fire Hazard Use a UL Listed grounding type plug rated 208-240 Volts, 15 Amperes, 1 Phase, 3 wire for single phase units. Plug to be selected and installed only by qualified service personnel.</p> </td> <td data-bbox="521 716 581 848"> <p>208-240V, 15A</p> </td> <td data-bbox="581 716 834 848">  <p>ADVERTENCIA/AVERTISSEMENT</p> <p>Peligro de incendio Utilice un enchufe con toma de tierra de los que se incluyen en las listas de la UL de 208-240 voltios, 15 amperios, monofásico de 3 hilos para unidades monofásicas. La selección e instalación del enchufe la realizará exclusivamente personal cualificado del servicio.</p> <p>Risque d'incendie Utilisez une prise homologuée UL, conforme pour 208-240 Volts, 15 Amperes, monophasé, 3 fils pour les appareils monophasés. Les prises ne doivent être sélectionnées et installées que par du personnel de service qualifié. L4-4548</p> </td> </tr> </table>	 <p>WARNING</p> <p>Fire Hazard Use a UL Listed grounding type plug rated 208-240 Volts, 15 Amperes, 1 Phase, 3 wire for single phase units. Plug to be selected and installed only by qualified service personnel.</p>	<p>208-240V, 15A</p>	 <p>ADVERTENCIA/AVERTISSEMENT</p> <p>Peligro de incendio Utilice un enchufe con toma de tierra de los que se incluyen en las listas de la UL de 208-240 voltios, 15 amperios, monofásico de 3 hilos para unidades monofásicas. La selección e instalación del enchufe la realizará exclusivamente personal cualificado del servicio.</p> <p>Risque d'incendie Utilisez une prise homologuée UL, conforme pour 208-240 Volts, 15 Amperes, monophasé, 3 fils pour les appareils monophasés. Les prises ne doivent être sélectionnées et installées que par du personnel de service qualifié. L4-4548</p>	<p>WARNING</p> <p>Fire hazard</p> <p>Use a UL Listed grounding type plug rated 208-240 Volts, 15 Amperes, 1 Phase, 3 wire for single phase units. Plug to be selected and installed only by qualified service personnel.</p>
 <p>WARNING</p> <p>Fire Hazard Use a UL Listed grounding type plug rated 208-240 Volts, 15 Amperes, 1 Phase, 3 wire for single phase units. Plug to be selected and installed only by qualified service personnel.</p>	<p>208-240V, 15A</p>	 <p>ADVERTENCIA/AVERTISSEMENT</p> <p>Peligro de incendio Utilice un enchufe con toma de tierra de los que se incluyen en las listas de la UL de 208-240 voltios, 15 amperios, monofásico de 3 hilos para unidades monofásicas. La selección e instalación del enchufe la realizará exclusivamente personal cualificado del servicio.</p> <p>Risque d'incendie Utilisez une prise homologuée UL, conforme pour 208-240 Volts, 15 Amperes, monophasé, 3 fils pour les appareils monophasés. Les prises ne doivent être sélectionnées et installées que par du personnel de service qualifié. L4-4548</p>			
<p>15</p>	<table border="1"> <tr> <td data-bbox="261 959 521 1092">  <p>WARNING</p> <p>Fire Hazard Use a UL Listed grounding type plug rated 120 Volts, 20 Amperes, 1 Phase, 3 wire for single phase units. Plug to be selected and installed only by qualified service personnel.</p> </td> <td data-bbox="521 959 581 1092"> <p>120V, 20A</p> </td> <td data-bbox="581 959 834 1092">  <p>ADVERTENCIA/AVERTISSEMENT</p> <p>Peligro de incendio Utilice un enchufe con toma de tierra de los que se incluyen en las listas de la UL de 120 voltios, 20 amperios, monofásico de 3 hilos para unidades monofásicas. La selección e instalación del enchufe la realizará exclusivamente personal cualificado del servicio.</p> <p>Risque d'incendie Utilisez une prise homologuée UL, conforme pour 120 Volts, 20 Amperes, monophasé, 3 fils pour les appareils monophasés. Les prises ne doivent être sélectionnées et installées que par du personnel de service qualifié. L4-4549</p> </td> </tr> </table>	 <p>WARNING</p> <p>Fire Hazard Use a UL Listed grounding type plug rated 120 Volts, 20 Amperes, 1 Phase, 3 wire for single phase units. Plug to be selected and installed only by qualified service personnel.</p>	<p>120V, 20A</p>	 <p>ADVERTENCIA/AVERTISSEMENT</p> <p>Peligro de incendio Utilice un enchufe con toma de tierra de los que se incluyen en las listas de la UL de 120 voltios, 20 amperios, monofásico de 3 hilos para unidades monofásicas. La selección e instalación del enchufe la realizará exclusivamente personal cualificado del servicio.</p> <p>Risque d'incendie Utilisez une prise homologuée UL, conforme pour 120 Volts, 20 Amperes, monophasé, 3 fils pour les appareils monophasés. Les prises ne doivent être sélectionnées et installées que par du personnel de service qualifié. L4-4549</p>	<p>WARNING</p> <p>Fire hazard</p> <p>Use a UL Listed grounding type plug rated 120 Volts, 20 Amperes, 1 Phase, 3 wire for single phase units. Plug to be selected and installed only by qualified service personnel.</p>
 <p>WARNING</p> <p>Fire Hazard Use a UL Listed grounding type plug rated 120 Volts, 20 Amperes, 1 Phase, 3 wire for single phase units. Plug to be selected and installed only by qualified service personnel.</p>	<p>120V, 20A</p>	 <p>ADVERTENCIA/AVERTISSEMENT</p> <p>Peligro de incendio Utilice un enchufe con toma de tierra de los que se incluyen en las listas de la UL de 120 voltios, 20 amperios, monofásico de 3 hilos para unidades monofásicas. La selección e instalación del enchufe la realizará exclusivamente personal cualificado del servicio.</p> <p>Risque d'incendie Utilisez une prise homologuée UL, conforme pour 120 Volts, 20 Amperes, monophasé, 3 fils pour les appareils monophasés. Les prises ne doivent être sélectionnées et installées que par du personnel de service qualifié. L4-4549</p>			
<p>16</p>	<table border="1"> <tr> <td data-bbox="261 1203 521 1335">  <p>WARNING</p> <p>Fire Hazard Use a UL Listed grounding type plug rated 208-240 Volts, 50 Amperes, 1 Phase, 3 wire for single phase units. Plug to be selected and installed only by qualified service personnel.</p> </td> <td data-bbox="521 1203 581 1335"> <p>208-240V, 50A</p> </td> <td data-bbox="581 1203 834 1335">  <p>ADVERTENCIA/AVERTISSEMENT</p> <p>Peligro de incendio Utilice un enchufe con toma de tierra de los que se incluyen en las listas de la UL de 208-240 voltios, 50 amperios, monofásico de 3 hilos para unidades monofásicas. La selección e instalación del enchufe la realizará exclusivamente personal cualificado del servicio.</p> <p>Risque d'incendie Utilisez une prise homologuée UL, conforme pour 208-240 Volts, 50 Amperes, monophasé, 3 fils pour les appareils monophasés. Les prises ne doivent être sélectionnées et installées que par du personnel de service qualifié. L4-4550</p> </td> </tr> </table>	 <p>WARNING</p> <p>Fire Hazard Use a UL Listed grounding type plug rated 208-240 Volts, 50 Amperes, 1 Phase, 3 wire for single phase units. Plug to be selected and installed only by qualified service personnel.</p>	<p>208-240V, 50A</p>	 <p>ADVERTENCIA/AVERTISSEMENT</p> <p>Peligro de incendio Utilice un enchufe con toma de tierra de los que se incluyen en las listas de la UL de 208-240 voltios, 50 amperios, monofásico de 3 hilos para unidades monofásicas. La selección e instalación del enchufe la realizará exclusivamente personal cualificado del servicio.</p> <p>Risque d'incendie Utilisez une prise homologuée UL, conforme pour 208-240 Volts, 50 Amperes, monophasé, 3 fils pour les appareils monophasés. Les prises ne doivent être sélectionnées et installées que par du personnel de service qualifié. L4-4550</p>	<p>WARNING</p> <p>Fire hazard</p> <p>Use a UL Listed grounding type plug rated 208-240 Volts, 50 Amperes, 1 Phase, 3 wire for single phase units. Plug to be selected and installed only by qualified service personnel.</p>
 <p>WARNING</p> <p>Fire Hazard Use a UL Listed grounding type plug rated 208-240 Volts, 50 Amperes, 1 Phase, 3 wire for single phase units. Plug to be selected and installed only by qualified service personnel.</p>	<p>208-240V, 50A</p>	 <p>ADVERTENCIA/AVERTISSEMENT</p> <p>Peligro de incendio Utilice un enchufe con toma de tierra de los que se incluyen en las listas de la UL de 208-240 voltios, 50 amperios, monofásico de 3 hilos para unidades monofásicas. La selección e instalación del enchufe la realizará exclusivamente personal cualificado del servicio.</p> <p>Risque d'incendie Utilisez une prise homologuée UL, conforme pour 208-240 Volts, 50 Amperes, monophasé, 3 fils pour les appareils monophasés. Les prises ne doivent être sélectionnées et installées que par du personnel de service qualifié. L4-4550</p>			

Dimension Drawings

300-TH

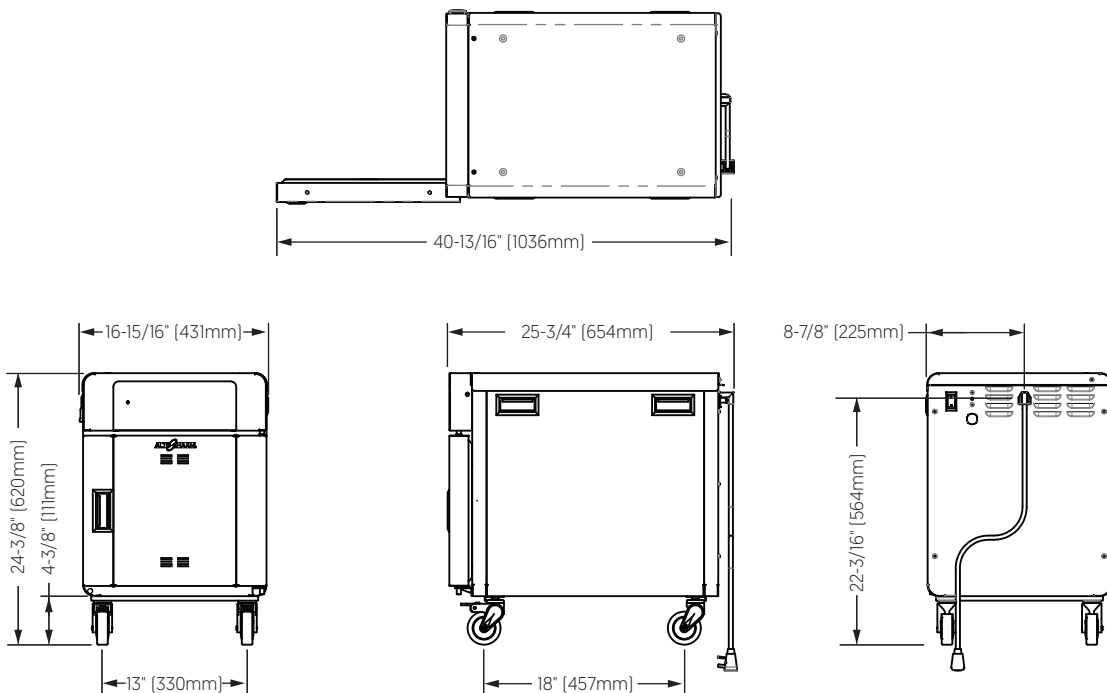
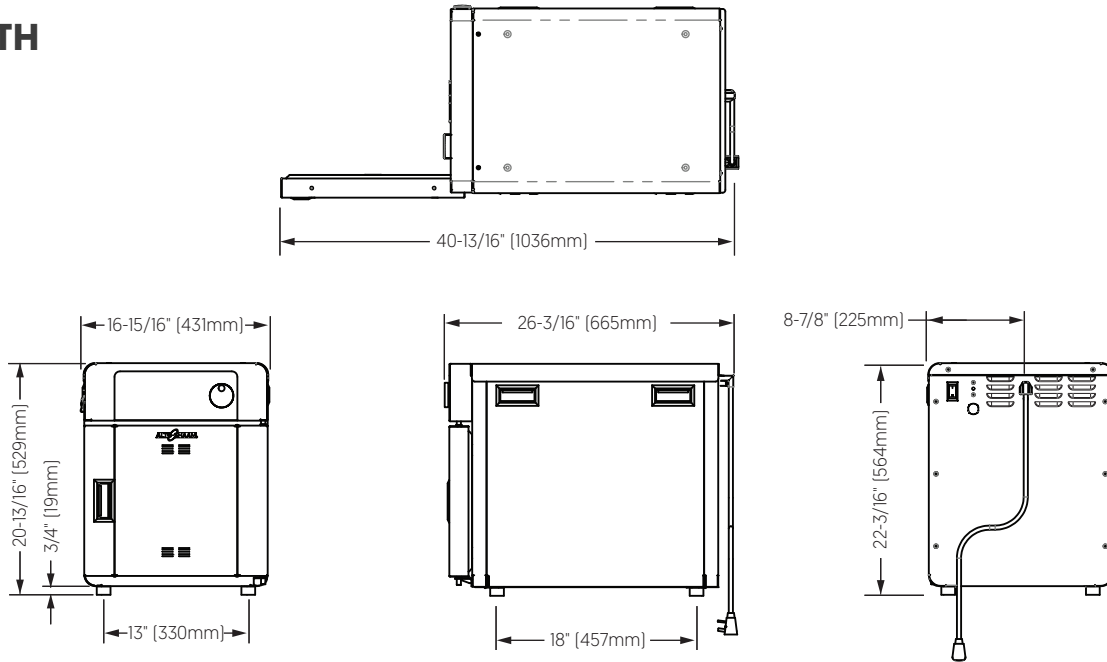

INSTALLATION

500-TH

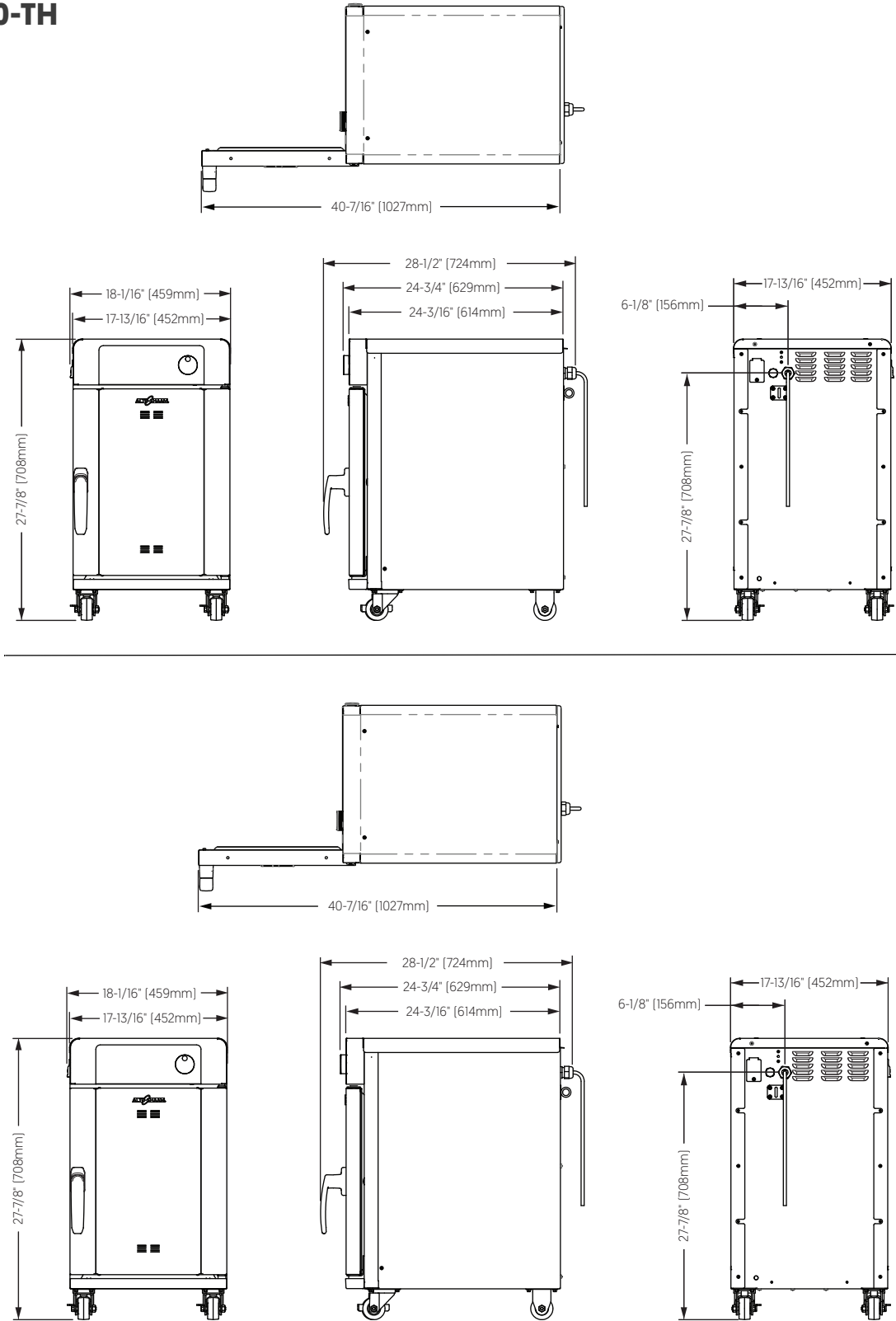

750-TH
750-SK

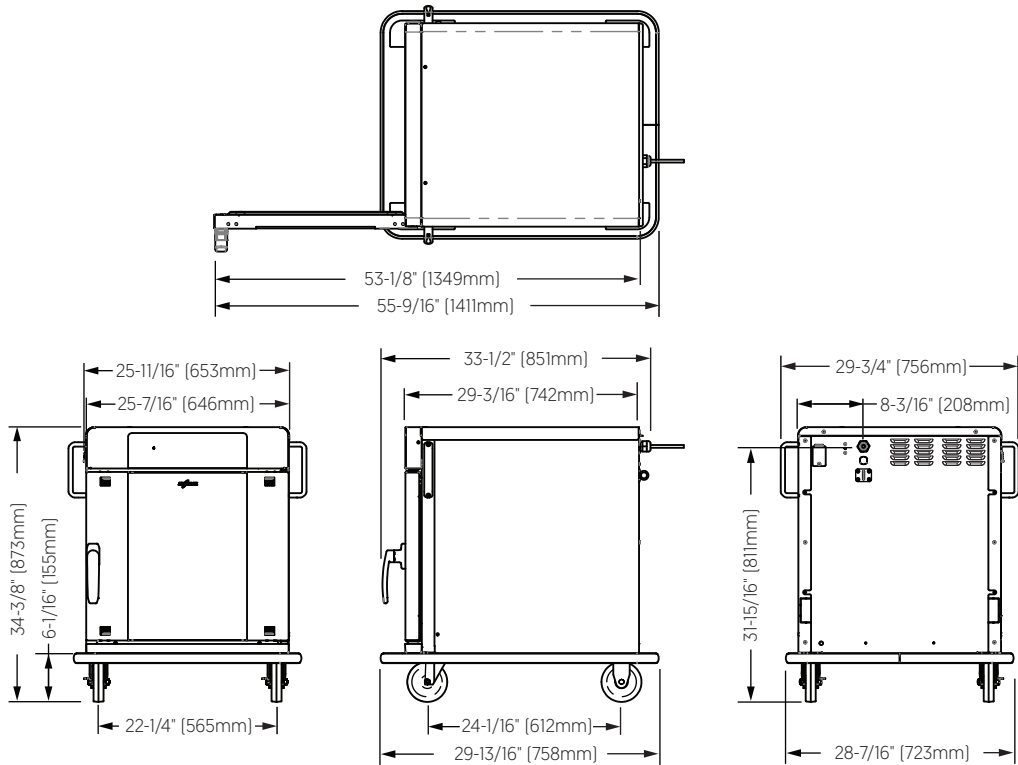
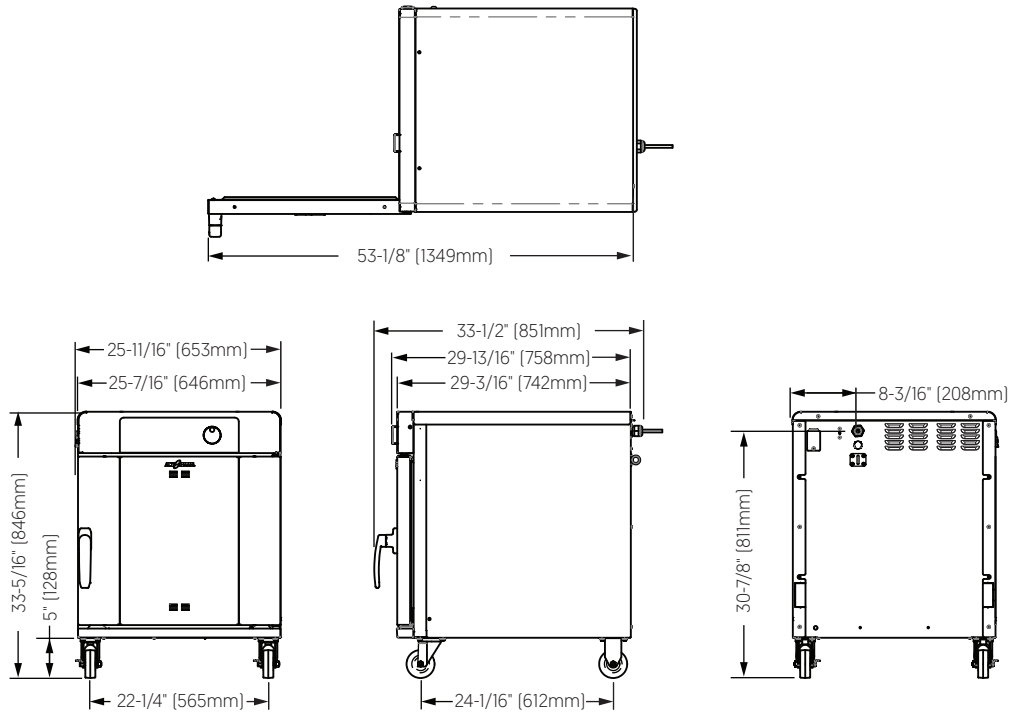

1000-TH 1000-SK

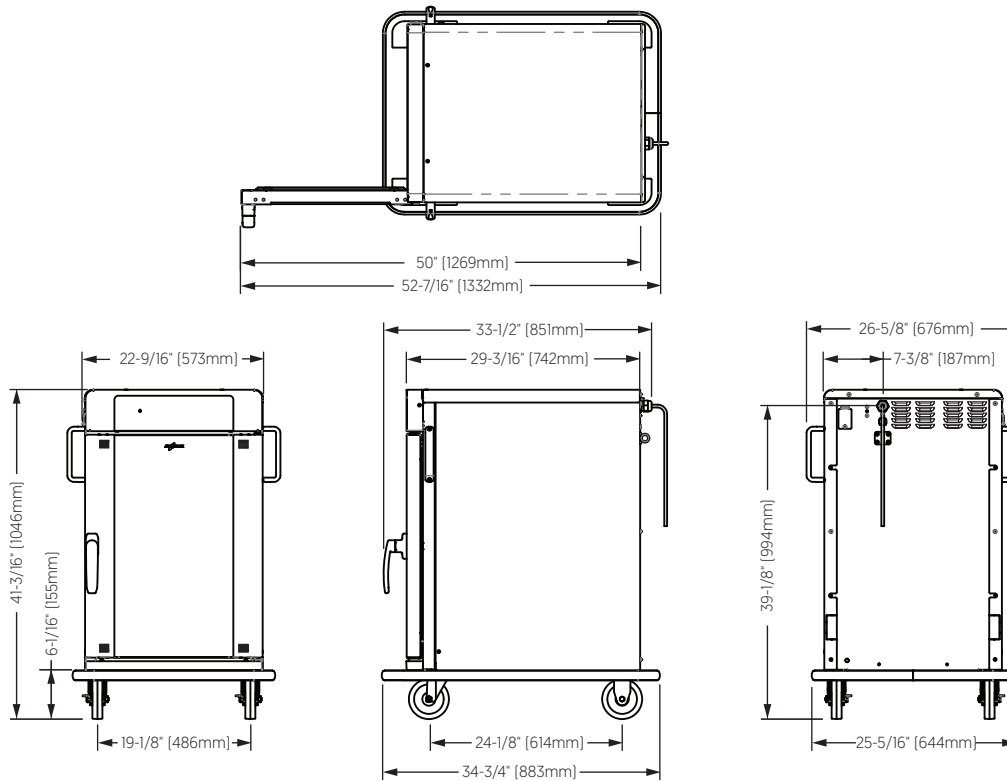
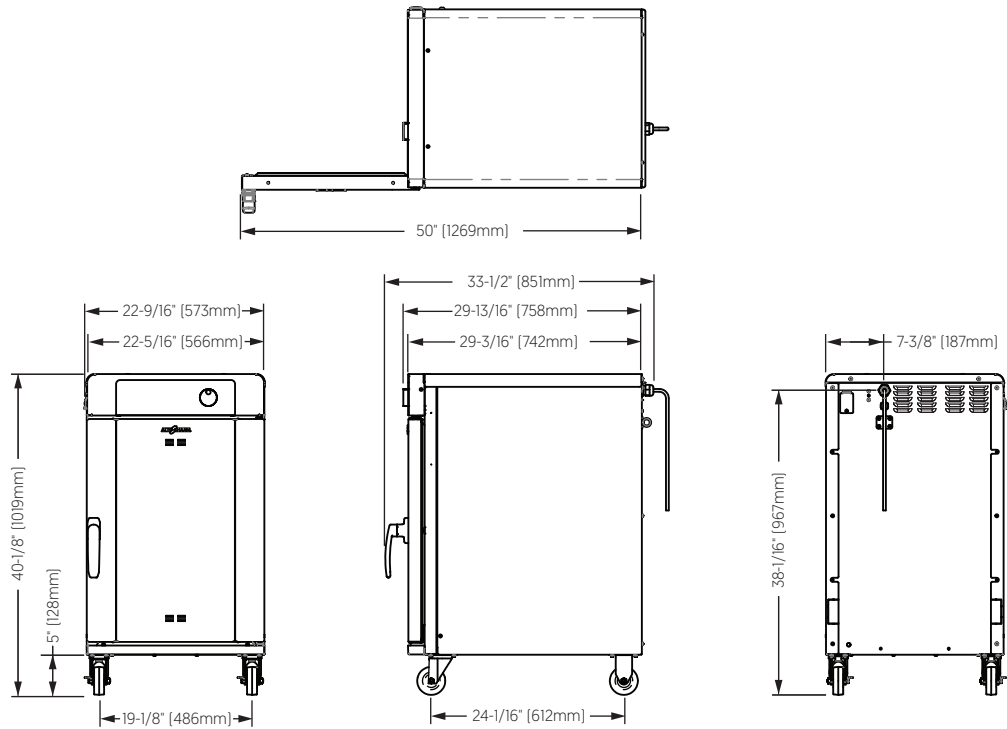

1200-TH
1200-SK

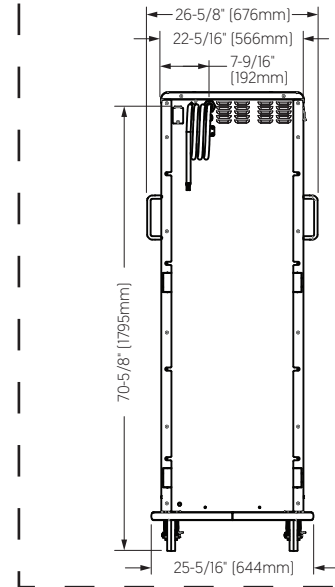
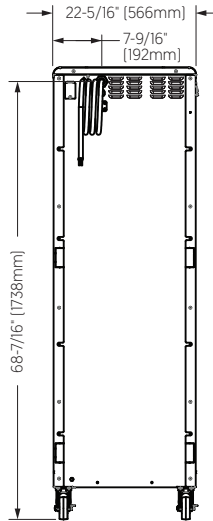
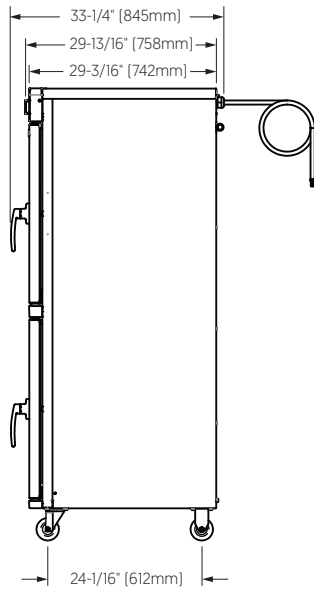
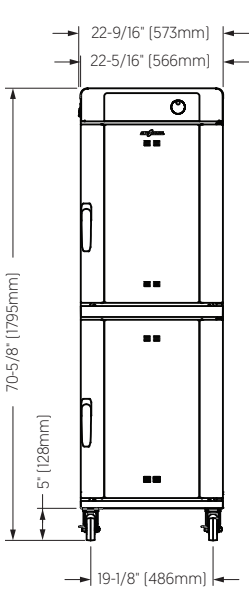
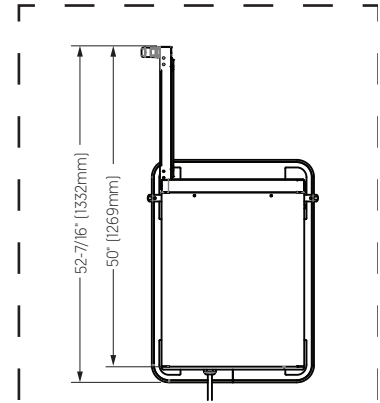
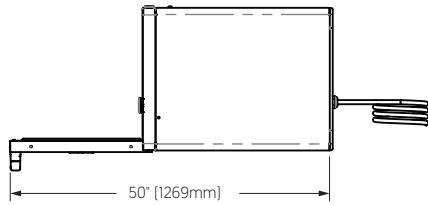

1750-TH 1750-SK

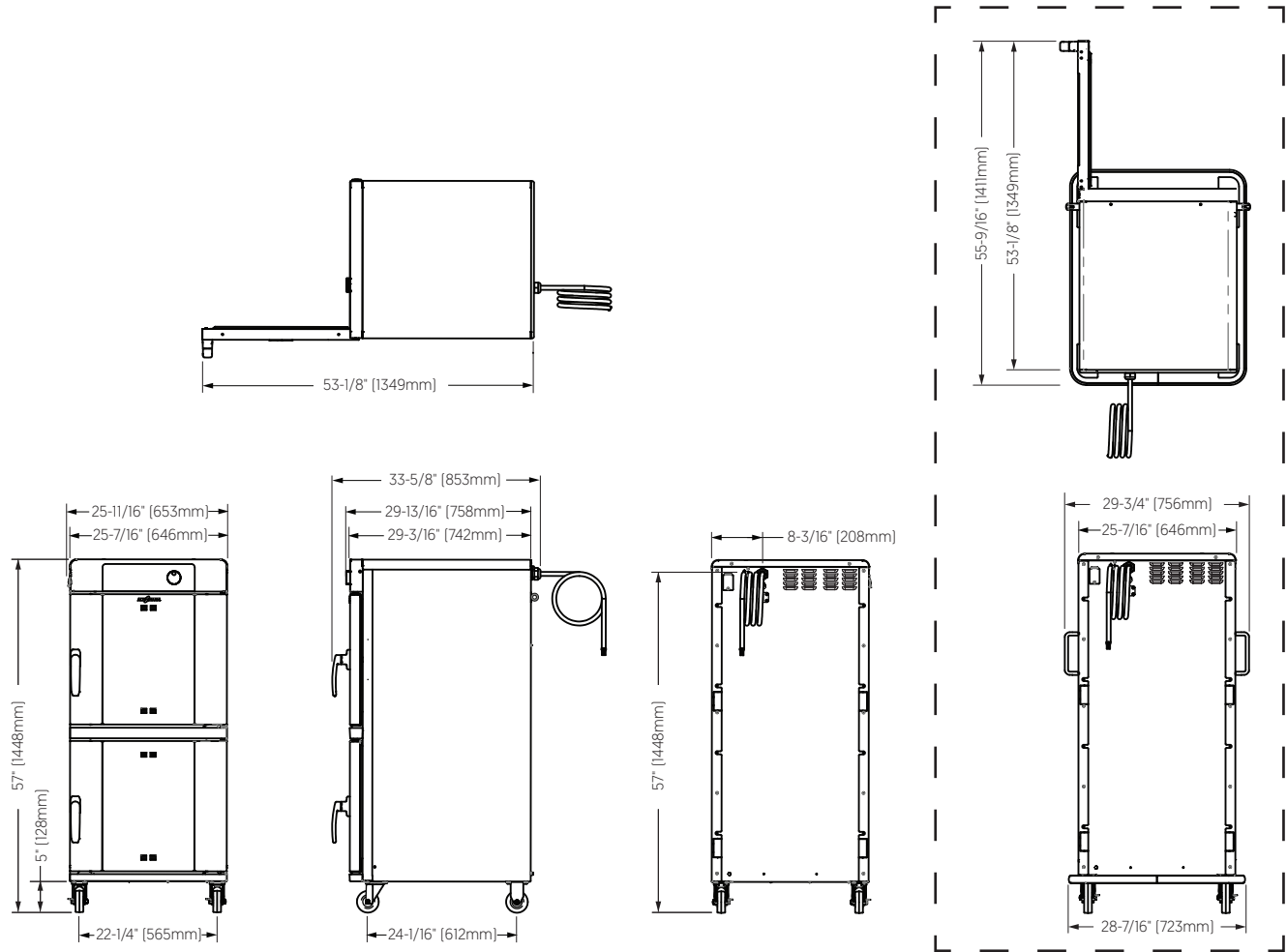

How to Receive the Appliance

Responsible parties

When an Alto-Shaam® preferred carrier is used, shipping damage is a matter between Alto-Shaam and the carrier. In such cases, contact Alto-Shaam customer service.

When an Alto-Shaam non-preferred carrier is used, shipping damage is a matter between the carrier and the consignee. In such cases, the carrier is assumed to be responsible for the safe delivery of the merchandise, unless negligence can be established on part of the shipper.

Receive the appliance

When receiving the appliance, do the following.

Step	Action
1.	Inspect the equipment while it is still in the truck or immediately after it is moved to the receiving area. Do not wait until after the equipment is moved to a storage area.
2.	Inspect and count all merchandise received. Do not sign a delivery receipt or a freight bill until you have done so.
3.	Note all damage to packaging and to the equipment on the carrier's receipt.
4.	Request the driver sign the delivery receipt. If the driver refuses to sign, make a note of this refusal on the delivery receipt.
5.	Write the following on the delivery receipt if the driver refuses to allow an inspection: Driver refuses to allow inspection of containers for visible damage.
6.	Contact the carrier immediately upon finding damage, and request an inspection. Follow the carrier's policies and procedures.

Alto-Shaam policy

It is the policy of Alto-Shaam to assist customers in collecting claims that have been properly filed and actively pursued. Alto-Shaam cannot, however, file damage claims, assume the responsibilities for damage claims, or accept deductions in payment for damage claims.

How to Unpack the Oven

Before you begin

Make sure you have:

- An appropriate lifting device and enough personnel to safely move and position the weight of the oven.
 - 300-TH/SK: 100 lbs (45 kg)
 - 500-TH/SK: 185 lbs (84 kg)
 - 750-TH/SK: 225 lbs (102 kg)
 - 1000-TH/SK: 250 lbs (113 kg)
 - 1200-TH/SK: 450 lbs (204 kg)
 - 1750-TH/SK: 440 lbs (200 kg)
- Cutting tools to remove the packaging.

Unpack the oven

To unpack the oven, do the following.

Step	Action
1.	Remove the box. Save all packing materials for inspection by the carrier. <div style="border: 1px solid gray; padding: 5px; margin-top: 10px;"> <p>NOTE: Examine the appliance for damage. If the appliance has been damaged, do not use the appliance until it has been inspected by an authorized service provider. Contact your carrier or Alto-Shaam® customer service.</p> </div>
2.	Remove the shrink wrap.
3.	Cut the restraining straps.
4.	Remove the oven from the pallet.

Result

The oven is now unpacked.

Pre-Installation Checklist

Installation of the oven is to be completed only by an authorized Alto-Shaam service partner.

Place this form with the oven's records.



WARNING: Electric shock and arc flash hazard.
Use caution when measuring line voltage and line current.
Wear Personal Protective Equipment (PPE).

Location Information

Installation date:	Start up date:
Location name:	Location address:
Contact name:	
Contact phone number:	Number of ovens to be installed:
Contact email:	Oven model number(s):
IT Administrator name: (if applicable)	Oven serial number(s):
Phone number:	Oven rated voltage:

Pre-Installation Company Information

Company name:	Mailing address:
Technician name:	
Technician phone number:	Technician email:
Date of Site Survey:	

Clearance

	Record	Pass	Fail
Measure door/entry way clearance (smallest dimension)			
Measure path clearance (smallest dimension)			
Elevator opening, if applicable (smallest dimension)			
Elevator interior dimensions, if applicable (HxWxD)			
Oven Clearance Right side:			
Rear:			
Left side:			
Top:			
Based on the oven's designated spot in the kitchen, is the oven accessible for service?	Yes / No		
If NO, comment on the issue:			
Other comments:			

Continued on next page

Continued from previous page

Electrical

Alto-Shaam oven ratings	Breaker:	Voltage:	Phase:	
	Cord:	Plug:		
Is the oven going to be hard wired?	Yes		No	
The following fields must be completed by the service technician on site.				
What is the measured voltage at the site?	L1-N:	L2-N:	L3-N:	L1-L2:
	L2-3:	L1-L3:	Pass	Fail
What is the on-site breaker size supplying power to the oven(s)?	Size:		Pass	Fail
Is there a disconnect or junction box within 3' (914mm) of where the oven(s) will be installed?	Pass	Fail		

Comments:

WiFi equipped ovens (Deluxe control only)

Is the WiFi system that will be used secure, WiFi Protected Access 2 (WPA2)? The WiFi system to be used cannot be Point of Sales WiFi.	Yes	No
Have you been provided the Service Set Identifier (SSID) for the system to be used?	Yes	No
Have you been provided the pass phrase for the WiFi system to be used?	Yes	No
At the final location that the oven will be installed, can you connect to the WiFi system with your phone?	Yes	No
At the final location that the oven will be installed, can you connect to Alto-Shaam.com with your phone using the WiFi system?	Yes	No
Is site action required?	Yes	No

Action required:

Other site information

Smoker ovens only - Is there a proper ventilation hood installed above where the oven(s) will be installed?	Pass	Fail
Does the designated location for the oven have a level surface, i.e., no more than 1.5" (38mm) change in elevation from its highest to lowest surface point?	Pass	Fail
Is the site 100% ready for oven(s) installation?	Pass	Fail
Is the ambient air temperature between 60°F (16°C) and 105°F (41°C)?	Pass	Fail
Is site action required?	Pass	Fail

Action required:

Continued on next page

Continued from previous page

Please provide a copy of this document to an on-site manager.

Service company name:

Service company number:

Model of oven(s) to be installed:

The site is ready for installation of the oven(s); planned install location passes inspection. Once the oven(s) arrive at the site (or the delivery date is certain), please contact the service company listed above to schedule the installation.

The site is NOT ready for installation of the oven(s); planned install location needs the following changes made before installation can proceed:

On-site manager should make the necessary contacts to move forward with these changes as soon as possible. If there are any questions, please contact Alto-Shaam Technical Service Department at 800-558-8744 ext. 6702.
Or, review documentation regarding the equipment www.alto-shaam.com/en/resource-library.

Once the necessary site changes have been made and the oven(s) have arrived (or the delivery date is certain), please contact the service company listed above to schedule the installation.

Technician name and signature:

On-site manager name and signature:

Installation Checklist

Installation of the oven is to be completed only by an authorized Alto-Shaam service partner.

Place this form with the oven's records.



WARNING: Electric shock and arc flash hazard.
Use caution when measuring line voltage and line current.
Wear Personal Protective Equipment (PPE).

Installation date:	Start up date:
Location name:	Location address:
Contact name:	
Contact phone number:	Oven model number:
Contact email:	Oven serial number:
IT Administrator name: (if applicable)	Oven rated voltage:
Phone number:	

Oven physical condition	Damaged		Record any damage with details before or after uncrating, location of damage, etc. Take pictures.
	Yes	No	
Front of oven			
Left side			
Back of oven			
Right side			
Top and bottom/legs			

Oven visual inspection (outside)	Yes	No
Is all packing material removed from the outside of the oven?		
Is all packing material removed from the inside of the oven?		

Oven visual inspection (internal)	Loose/Damaged	
	Yes	No
Check all electrical connections at each terminal block.		
Check all circuit board connections.		
Check all components for loose connections and hardware.		
Check the overall system for any damage from shipping or installation.		

Continued on next page

Continued from previous page

Electrical:	Record		
Measure the voltage at the wall outlet.	L1 to L2:	L1 to L3:	L2 to L3:
Measure the voltage at the oven's main disconnect switch.	L1 to L2:	L1 to L3:	L2 to L3:
Measure the voltage at the oven's main terminal block.	L1 to L2:	L1 to L3:	L2 to L3:
Measure the AC voltage to the 12 VDC power supply.			
Measure the DC output from the power supply.			

Wifi equipped ovens:

Navigate to the settings screen; touch the network icon.



On the Your network status screen:	Wireless		Ethernet
What is the connection type?			
What color is the network icon?	Red	Yellow	Green
What is the Internet status?			
What is the Cloud status?			
What is the SSID?			
What is the IP Address?			

How to Install the Oven

Before you begin

Make sure you have an appropriate lifting device, and enough personnel, to safely move and position the weight of the oven.

Requirements

- The oven must be installed on a level surface.
- The oven must not be installed in any area where it may be affected by steam, grease, dripping water, high temperature, or any other severely adverse conditions.

Voltages

	V	Ph	Hz	AWG	A	Breaker*	kW	Plug***	
300-TH 230V	120	1	60	14	6.7	15	0.8	NEMA 5-15P 15A-125V CEE 7/7, BS-1363, CH2-16P	
	230	1	50/60	14	3.2	16	0.7		
500-TH 120V	120	1	60	10	16	20	1.9	NEMA 5-20P 20A-125V	
	208-240V**	208	1	60	10	11	15 UL 20 CSA	2.3	No cord, no plug
		240	1	60	10	13	15 UL 20 CSA	3.0	
230V	230	1	50/60	10	12	16	2.8	CEE 7/7, BS-1363, CH-16P	
750-TH 120V	120	1	60	10	14	20	1.7	NEMA 5-20P 20A-125V	
	208-240V**	208	1	60	10	15	20 UL 30 CSA	3.1	No cord, no plug No cord, no plug
		240	1	60	10	17	20 UL 30 CSA	4.2	
	230V	230	1	50/60	10	17	32	3.8	CEE 7/7, BS-1363, CH-16P, CH2-16P
230		1	50/60	10		16	2.6^		
750-SK 120V**	120	1	60	10	17	20	2.0	No cord, no plug	
	208-240V**	208	1	60	10	17	20 UL 30 CSA	3.5	No cord, no plug No cord, no plug
		240	1	60	10	19	20 UL 30 CSA	4.5	
	230V	230	1	50/60	10	18	32	4.2	No cord, no plug
230		1	50/60	10		16	2.9^	CEE 7/7, BS-1363, CH-16P, CH2-16P,	

*Electrical connections must meet all applicable federal, state, and local codes.

**Dedicated circuit required.

***Additional cord and plug configurations available from factory.

^ Reduced wattage configuration.

Continued on next page

Continued from previous page

	V	Ph	Hz	IEC	AWG	A	Breaker	kW	Plug
1000-TH									
120V	120	1	60	—	10	16	20 UL 30 CSA	1.9	***
208-240V**	208	1	60	—	10	15	20 UL 30 CSA	3.1	
	240	1	60	—	10	17	20 UL 30 CSA	4.1	
230V	230	1	50/60	—	10	16	32	3.8	
	230	1	50/60	—	10		16	2.9^	
1000-SK									
120V	120	1	60	—	10	18	20 UL 30 CSA	2.2	***
208-240V**	208	1	60	—	10	17	20 UL 30 CSA	3.4	
	240	1	60	—	10	19	20 UL 30 CSA	4.5	
230V	230	1	50/60	—	10	18	32	4.1	
	230	1	50/60	—	10	16	16	2.9^	
1200-TH									
208-240V**	208	1	60	—	8	29	30 UL 50 CSA 50	6.2	***
	240	1	60	—	8	34		8.2	
230V	230	1	50/60	—	8	33	63	7.5	
	230	1	50/60	—	8	22	32	5.0^	
380-415V	380	3	50/60	2.5	10	18	32	6.9	
	415	3	50/60	2.5	10	20	32	8.2	
1200-SK									
208-240V**	208	1	60	—	8	33	50	6.9	***
	240	1	60	—	8	37	50	8.9	
230V	230	1	50/60	—	8	36	50	8.3	
	230	1	50/60	—	8	25	32	5.7^	
380-415V	380	3	50/60	2.5	10	20	25	7.7	
	415	3	50/60	2.5	10	22	32	8.9	
1750-TH									
208-240V**	208	1	60	—	8	29	30 UL 50 CSA 50	6.3	***
	240	1	60	—	8	35		8.3	
230V	230	1	50/60	—	8	33	63	7.6	
	230	1	50/60	—	8	22	32	5.1^	
380-415V	380	3	50/60	2.5	10	18	32	7.0	
	415	3	50/60	2.5	10	20	32	8.2	
1750-SK									
208-240V**	208	1	60	—	8	33	50	7.0	***
	240	1	60	—	8	38	50	9.0	
230V	230	1	50/60	—	8	36	63	8.3	
	230	1	50/60	—	8	25	32	5.8^	
380-415V	380	3	50/60	2.5	10	20	32	7.6	
	415	3	50/60	2.5	10	22	32	8.9	

*Electrical connections must meet all applicable federal, state, and local codes.

**Dedicated circuit required.

***No cord or plug. Additional cord and plug configurations available from factory.

^ Reduced wattage configuration.

Continued on next page

Continued from previous page

Electrical connection



WARNING: Appliances without a cord provided by the factory must be equipped with a cord of sufficient length to permit the appliance to be moved for cleaning.

Always use the correct AWG wire size based on the electrical requirements for the appliance.



WARNING: To prevent serious injury, death, or property damage:

All electrical connections must be made by a qualified and trained service technician in accordance with applicable electrical codes.

This appliance must be adequately grounded in accordance with local electrical codes or, in the absence of local codes, with the current edition of the National Electrical Code ANSI/NFPA No 70. In Canada, all electrical connections are to be made in accordance with CSA C22 1, Canadian Electrical Code Part 1 or local codes.

CE-approved appliances include an equipotential-bonding terminal marked with the equipotential symbol. Provisions for earthing are to be made in accordance with IEC:2010 60335-1 section 27 or local codes.



CAUTION: Electrical shock hazard.

Power source must match voltage identified on appliance rating tag. The rating tag provides essential technical information required for any appliance installation, maintenance or repairs. Do not remove, damage or modify the rating tag.

Continued on next page

Continued from previous page

Regarding international standard ovens:

If the unit is not equipped with flexible cord and plug, an all-pole country approved disconnection device which has a contact separation of at least 3mm in all poles must be incorporated in the fixed wiring for disconnection. When using a cord without a plug, the green/yellow conductor shall be connected to the terminal which is marked with the ground symbol. If a plug is used, the socket outlet must be easily accessible. If the power cord needs replacement, use a similar one obtained from the distributor.

Hard-wired models:

Hard-wired models must be equipped with a country-certified, external, all-pole disconnection switch with sufficient contact separation. Hard-wired models that are mounted on casters must have a strain relief device (tether) to prevent strain on the power supply cord. If a power cord is used for the connection of the product, an oil resistant cord like H05RN or H07RN or equivalent must be used.

NOTICE Where local codes and CE regulatory requirements apply, appliances must be connected to an electrical circuit that is protected by an external GFCI outlet.

Restraint Requirements



WARNING: Electrical shock hazard

Appliance must be secured to building structure. Failure to observe this precaution may result in severe personal injury and damage to the equipment.

Requirements for restraint:

- Maximum height of casters is 6" (152mm).
- Two of the casters must be of the locking type.
- Strain relief devices (tethers) must be secured to the building structure.

A mounting connector for a restraining device (tether) is located on the back of the appliance. The restraining device (tether) is not supplied by nor is it available from the factory.

Continued on next page

Continued from previous page

Position the oven

To position the oven, do the following.

Step	Action
1.	<p>Make sure that:</p> <ul style="list-style-type: none"> The location where the oven is being installed is rated to support the weight of the oven; The oven is within five feet (1.5 m) of the appropriate electrical outlet; You follow the oven clearance guidelines.
2.	<p>Move the oven to the installation location and onto the final resting surface. Apply the brakes of the front casters.</p>
3.	<p>See topic <i>How to Clean the Oven</i>, and thoroughly clean the oven before continuing.</p>
4.	<p>For ovens without plugs and cords, do the following (See topic <i>How to Connect the Electrical Wiring</i>).</p> <ol style="list-style-type: none"> Remove the top panel. Remove the cord grip that came with the oven from the restraint connector and insert it into the power connection hole. Connect the power wires to the terminal block and circuit breakers. Secure the cord with the cord grip. Tighten the cord grip nut. Re-install the top panel. <p>For ovens with plugs and cords, do the following.</p> <p>Plug the oven into a properly grounded receptacle.</p>

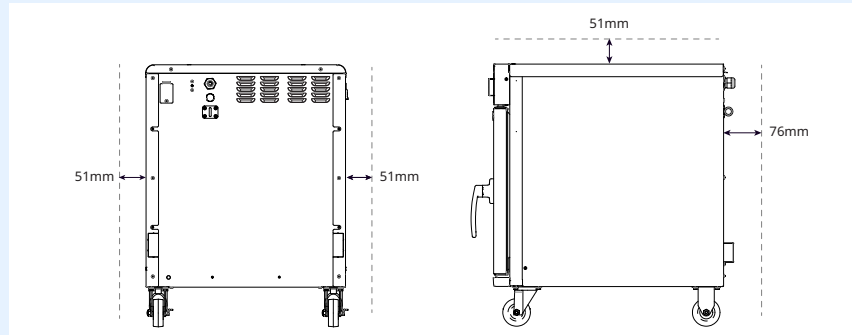

Connecting power

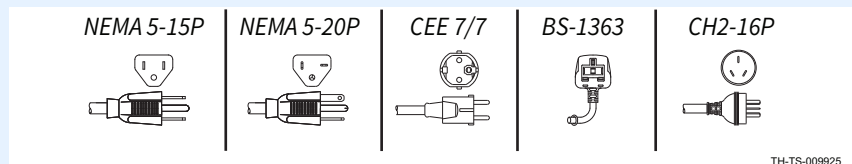

TH-TS-009925

Continued on next page

Continued from previous page

High limit reset

5. **Press and release** the high-limit temperature reset button ①.

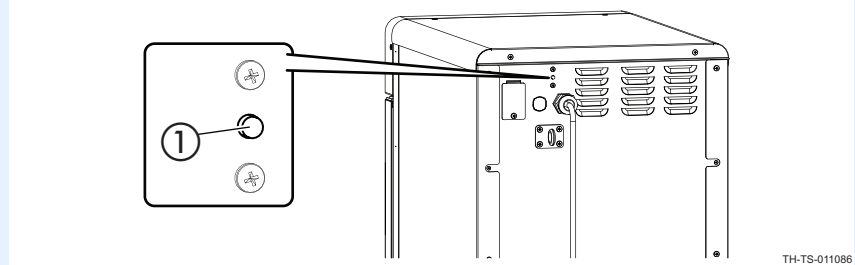

TH-TS-011086

Install the tether (if required)

6. For hard-wired ovens with casters, **install** the tether to the wall so that no stress is transmitted to the electrical cord when the oven moves.

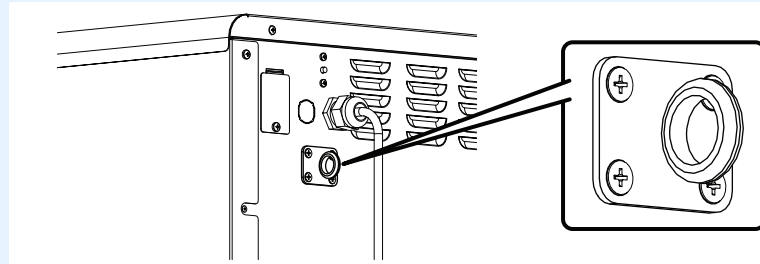

TH-TS-011090

Result

The oven is now installed.

How to Connect the Electrical Wiring

Before you begin

Make sure the power is off or disconnected at the supply.

Warnings



WARNING: Appliances without a cord provided by the factory must be equipped with a cord of sufficient length to permit the appliance to be moved for cleaning.

Always use the correct AWG wire size based on the electrical requirements for the appliance.



WARNING: To prevent serious injury, death, or property damage:

All electrical connections must be made by a qualified and trained service technician in accordance with applicable electrical codes.

This appliance must be adequately grounded in accordance with local electrical codes or, in the absence of local codes, with the current edition of the National Electrical Code ANSI/NFPA No 70. In Canada, all electrical connections are to be made in accordance with CSA C22 1, Canadian Electrical Code Part 1 or local codes.

CE-approved appliances include an equipotential-bonding terminal marked with the equipotential symbol. Provisions for earthing are to be made in accordance with IEC:2010 60335-1 section 27 or local codes.



CAUTION: Electrical shock hazard.

Power source must match voltage identified on appliance rating tag. The rating tag provides essential technical information required for any appliance installation, maintenance or repairs. Do not remove, damage or modify the rating tag.

Continued on next page

Continued from previous page

Procedure

To connect the electric power, do the following.

Step	Action
------	--------

1. **Remove** the top panel.

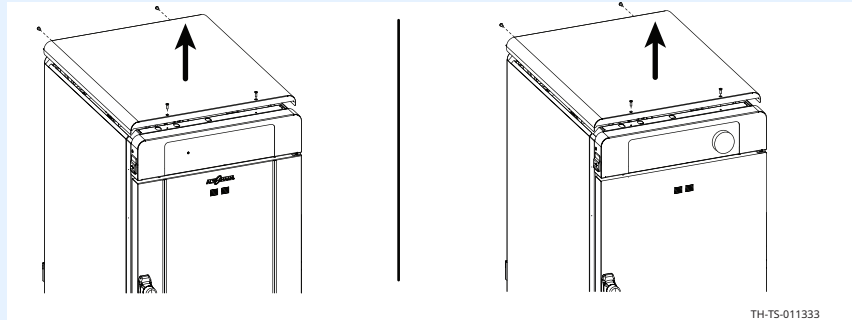

2. **Install** the cord grip into the back panel of the oven. **Install** the cord grip nut.

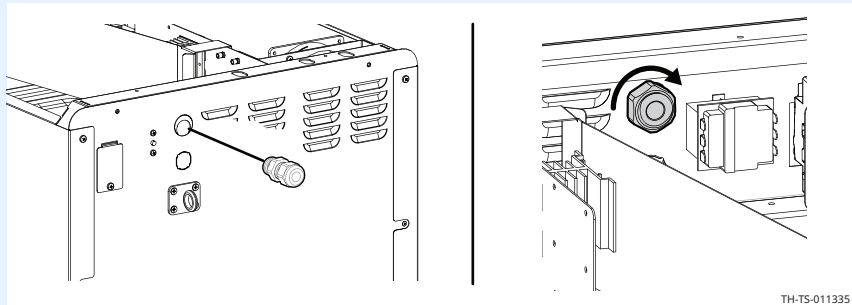

3. **Install** the cord through the cord grip. **Route** the ground wire to the terminal block.

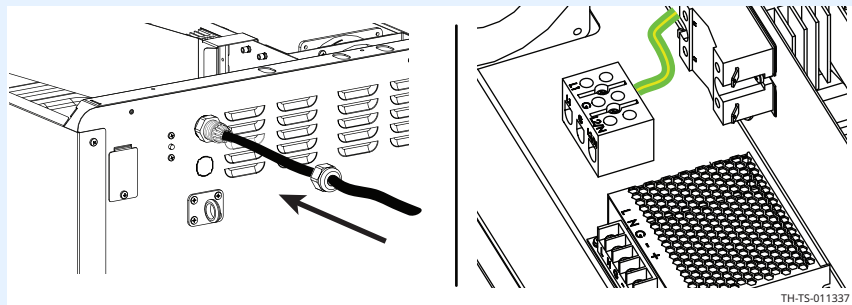

Continued on next page

Continued from previous page

4. **Remove** the screws retaining the circuit breakers ①. **Connect** the wires to the circuit breakers ②.

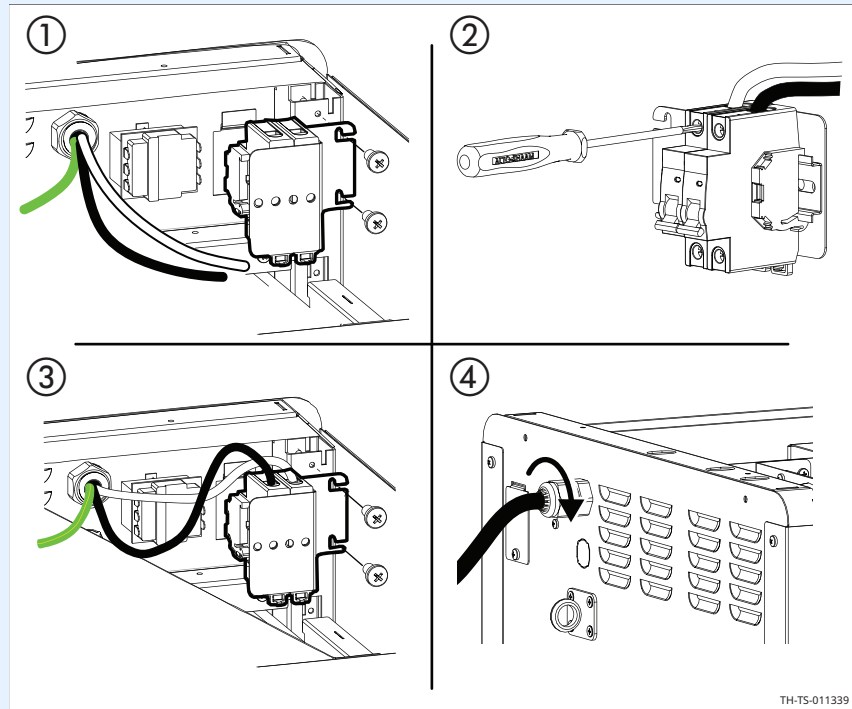

Re-install the circuit breakers with the screws ③.

Adjust the length of the cord. **Install** and tighten the cord grip nut ④.

5. **Re-install** the top panel.

Result

The electrical wiring is now connected.

How to Install the Drip Tray

Before you begin

Remove the drip tray from the oven cavity and remove any packaging.



WARNING: Slip Hazard

Failure to install the drip tray may result in moisture dripping on the floor. Be sure the drip tray is installed before using.

NOTICE

Failure to install the drip tray could result in equipment damage.

Procedure

To install the drip tray, do the following.

Step	Action
1.	Align the holes in the drip tray with the two studs located on the front of the oven.
2.	Hang the drip tray on the studs and press downward to lock it into place.

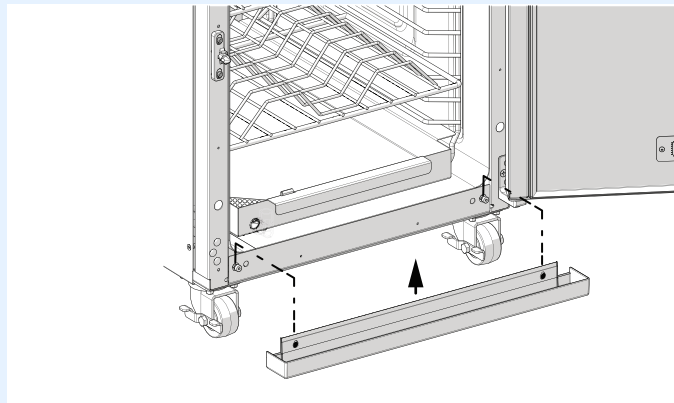

TH-TS-0009933

Result

The drip tray is installed.

How to Stack Two Ovens

Before you begin

Make sure you have:

- Industrial-grade silicone RTV
- An appropriate lifting device, and enough personnel, to safely move and position the weight of the oven.
 - 500-TH/SK: 185 lb (84 kg)
 - 750-TH/SK: 225 lb (102 kg)
 - 1000-TH/SK: 250 lb (113 kg)

Procedure

To stack the ovens, do the following.

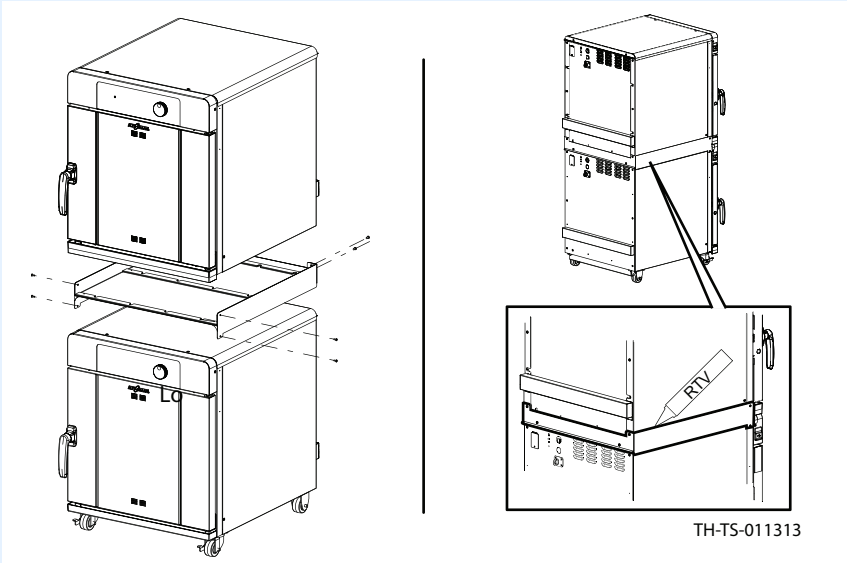
Step	Action
1.	Remove all packing material from each oven.
2.	Install the stacking kit to the bottom oven using the screws from the kit.
 <p style="text-align: right; margin-right: 50px;">TH-TS-011313</p>	
3.	Remove the casters from the upper oven if required.
4.	Using an appropriate lifting device, lift the upper oven and set it on the bottom oven. Secure the upper oven to the bottom oven using the screws from the kit. Apply a bead of silicone RTV on the three upper edges of the stacking kit.

Result

The ovens are now stacked.

How to Turn On and Turn Off the Oven

Before you begin

The oven must be connected to electric power.

Turning on the oven

To turn on the oven, do the following.

Step	Action
1.	<p>Set the power switch ① to the ON position (300-TH only). Touch and hold the ON/OFF button ② for two (2) seconds.</p>  <p>The oven is now on.</p>
2.	<p>To turn off the oven, do the following.</p> <p>Touch and hold the ON/OFF button for 5 seconds. The Shut Down Options screen displays.</p>  <p>3.</p>

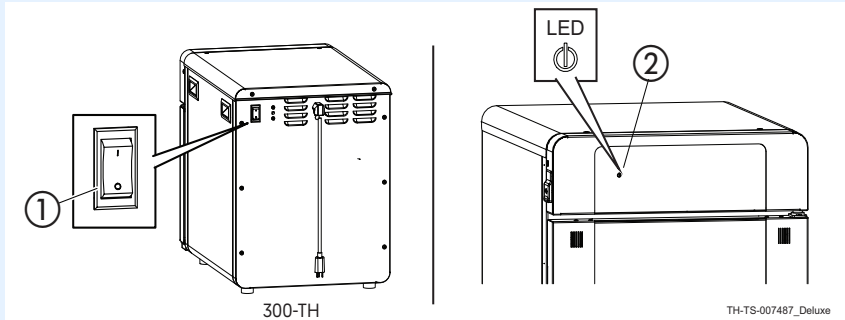

Turning off the oven

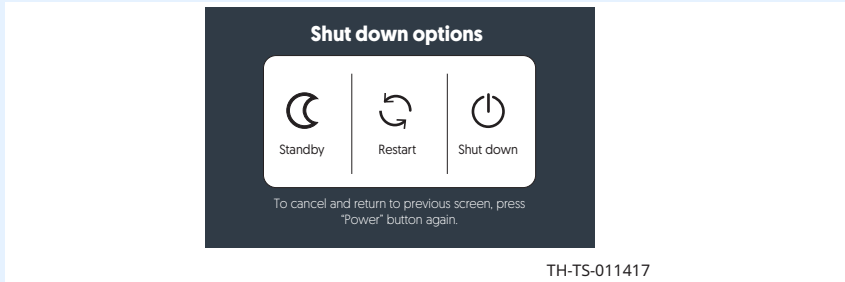

Result

The oven is now off.

How to Prepare the Oven for First Use

Background

Use this procedure for initial use or before using the oven after taking it out of storage.

Procedure

To prepare the oven for first use, do the following.

Step	Action
1.	Remove all packing material from the oven.
2.	Remove and wash detachable items such as wire racks, side racks, and drip pans. Wash these items with hot soapy water. Dry them with a clean, lint-free cloth.
3.	Remove visible grease or oil from the oven.
4.	Clean the interior and exterior of the oven with a mild soap and water solution. Dry with a clean, lint-free cloth.
5.	Clean the glass, if applicable, with glass cleaner or distilled vinegar.
6.	Re-install the wire racks, side racks, and drip pan.
7.	Turn on the oven and operate it without food for two hours at a temperature of 300°F (149°C) to remove surface oils and any accompanying odor.

Result

The oven is now ready for operation.

How to View and Set up WiFi Connection

Before you begin

- The facility must have WiFi.
- Do not connect to a guest network.

Procedure

To set up WiFi, do the following.

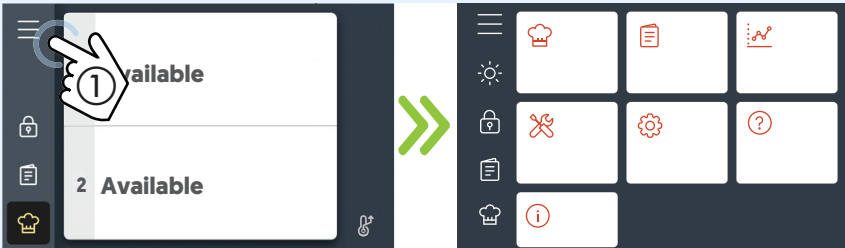
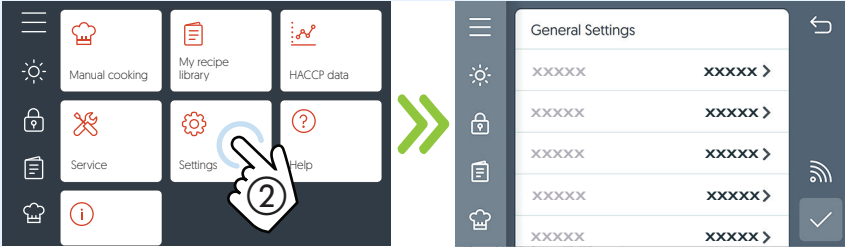
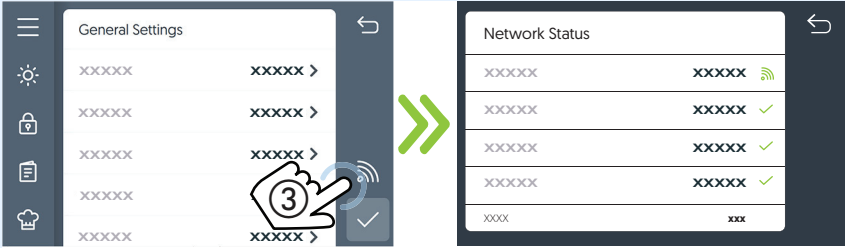
Step	Action
1.	<p>Touch the menu icon ①. The menu screen displays.</p>  <p style="text-align: right; font-size: small;">TH-TS-009945</p>
2.	<p>Touch the settings icon ②. The general settings screen displays.</p>  <p style="text-align: right; font-size: small;">TH-TS-011442</p>
3.	<p>Touch the WiFi icon ③. The Network Status screen displays.</p>  <p style="text-align: right; font-size: small;">AS-TS-009332</p>

Continued on next page

Continued from previous page

4. **Scroll** to “Connection settings”. **Touch** the Setup Network icon ④.

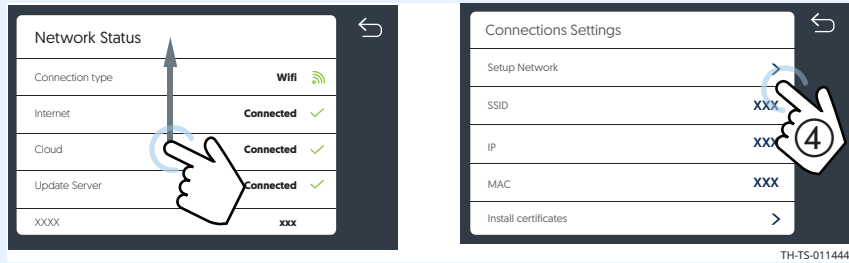

5. **Touch** the WiFi icon ⑤.

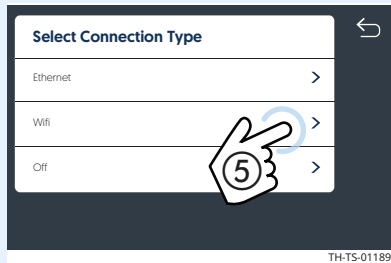

The available networks will show on the screen. The color of the network icon indicates the strength of the signal for each network.

- Green = strong
- Yellow = medium
- Red = weak

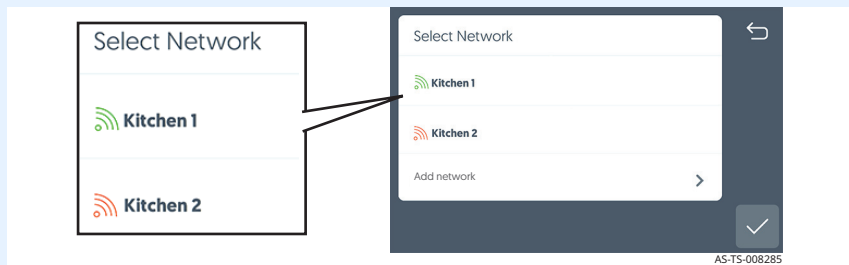

Continued on next page

Continued from previous page

6. If the network is not displayed, **touch** the “Add network” icon ⑥.



Enter the SSID using the keypad. Then, **touch** the arrow key.

Enter the security type. Then, **touch** the check mark.

Enter the password using the keypad. Then, **touch** the arrow key.

Touch the check mark when finished.

Result

The procedure is now complete.

How to Set up an Ethernet Connection

Before you begin

- The facility must have an Ethernet port.
- You will need an Ethernet cable.

Procedure

To set up an Ethernet connection, do the following.

Step	Action
------	--------

- | | |
|----|---|
| 1. | Plug the Ethernet cord into the Ethernet port on the oven and the wall outlet. |
|----|---|

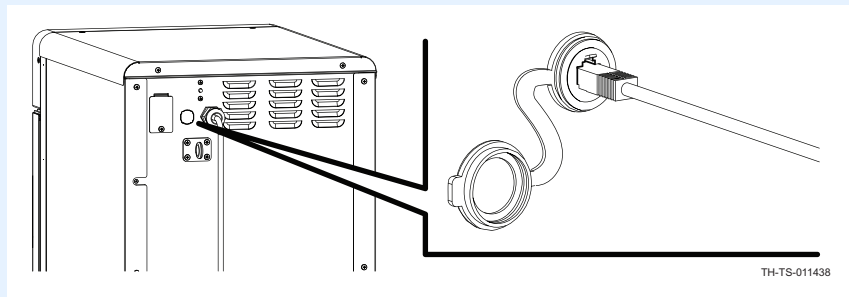

- | | |
|----|---|
| 2. | Touch the menu icon ①. The menu screen displays. |
|----|---|

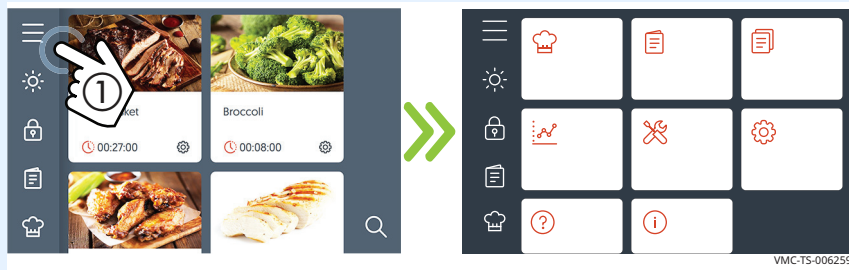

- | | |
|----|---|
| 3. | Touch the settings icon ②. The general settings screen displays. |
|----|---|

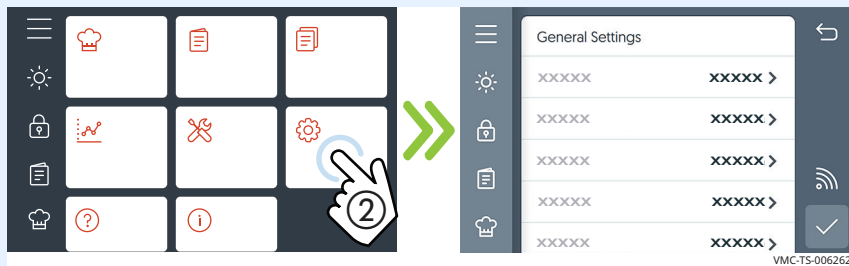

Continued on next page

Continued from previous page

4. **Touch** the WiFi icon ③. The Network Status screen displays.

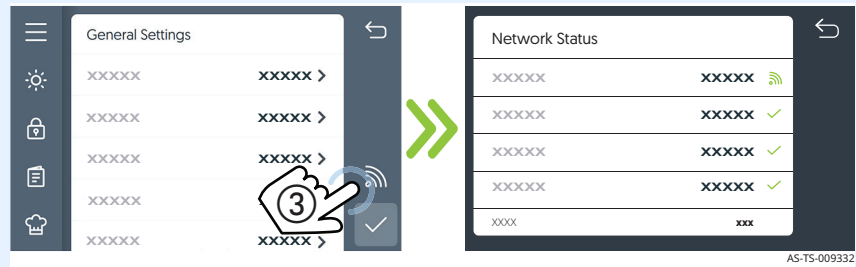

5. **Scroll** to “Connection settings”. **Touch** the Setup Network icon ④.

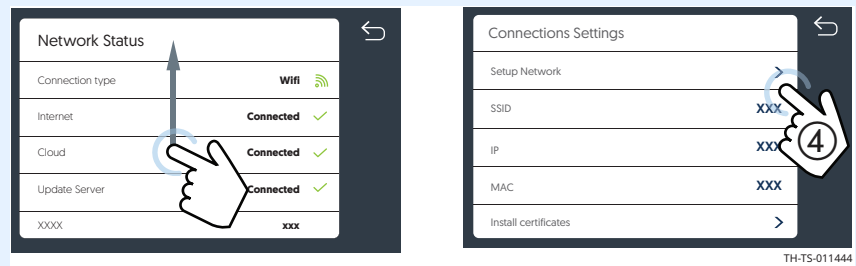

6. **Touch** the Ethernet icon ⑤. Follow any prompts.

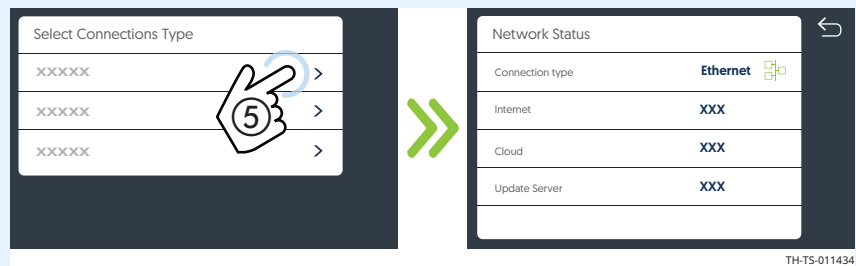

Result

The Ethernet connection is now set up.

How to Use the Door Vents

Before you begin

The door vents provide ventilation for the oven cavities. The door vents can be adjusted to give you the best results for the food you are cooking.

Settings

To set the vents, use the following suggestions.

Cooking type	Vent position
General cooking	All half open
Smoking	All closed
To maintain moisture	All closed
To remove excess moisture	All open
To balance moisture	Lower closed, upper half open

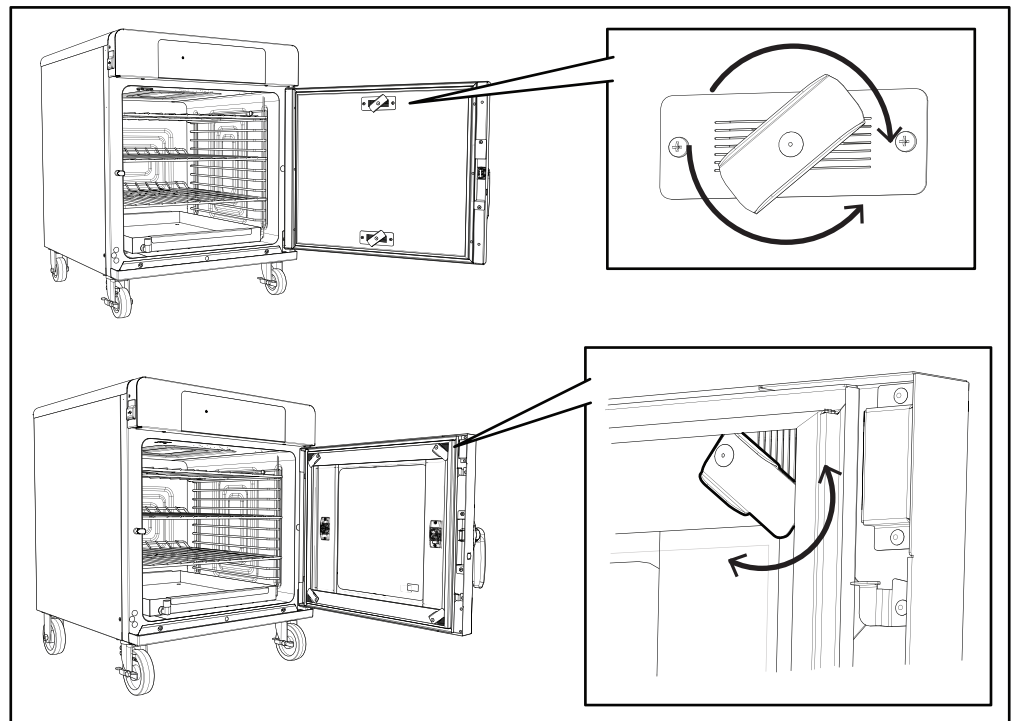

TH-TSK-011432

How to Preheat the Oven

Before you begin

- **Turn on** the oven.
- **Close** the oven door.

Procedure

To preheat the oven, do the following.

Step Action

1. **Touch** the professional cook icon ① if necessary to get to the manual cook screen. **Touch** the desired cavity ②.

If a preheat temperature has been previously set, touch the preheat-all icon ⑧. The oven will preheat to the default temperature. If not, continue.

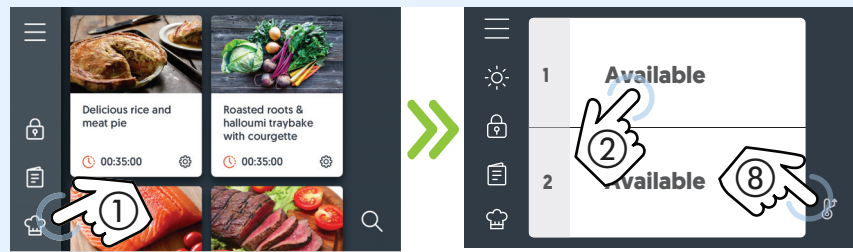

TH-TS-011895

Set the preheat

2. **Touch** the Preheat icon ③.

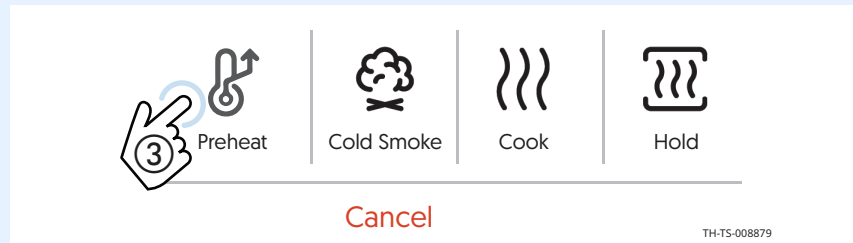

TH-TS-008879

3. **Touch** the preheat temperature ④. **Enter** a preheat temperature using the number pad ⑤. **Touch** the check mark ⑥.

Touch the green arrow ⑦. The preheat stage starts.



TH-TS-007266

Result

The oven is preheating.

How to Cook with Programmed Recipes

Before you begin

Be sure your food is prepared and ready to cook.

Procedure

To cook using a programmed recipe, do the following.

Step	Action
------	--------

1. **Touch** the recipes icon ①. The Browse recipes screen displays.

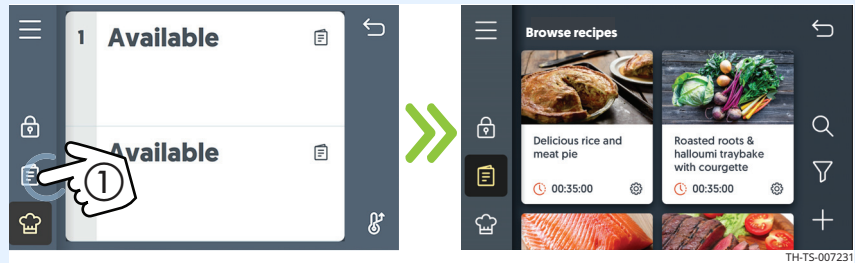

2. **Navigate** to the desired recipe. **Touch** the recipe ②.
Touch the green arrow ③.

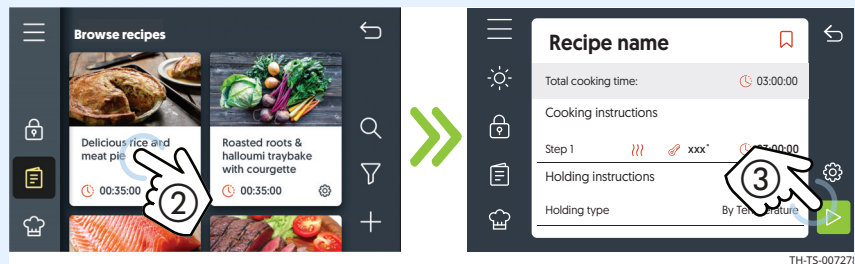

3. **Touch** the desired chamber you want to cook in ④.
Touch the green arrow ⑤. The programmed recipe will start the preheat stage.

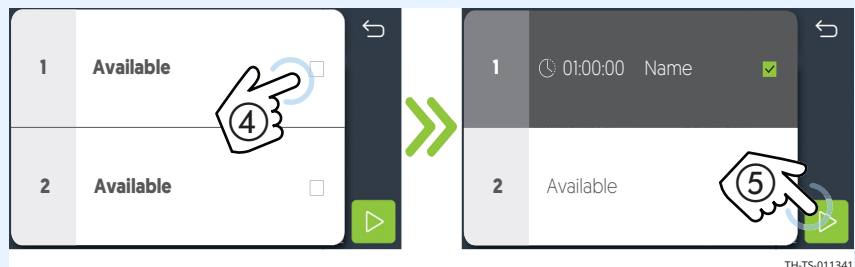

Continued on next page

Continued from previous page

Load the food

4. At the end of the preheat stage, the oven sounds an alert and displays the "Ready" screen. **Load** the food into the oven. **Touch** the action hand (6). The cooking process starts.

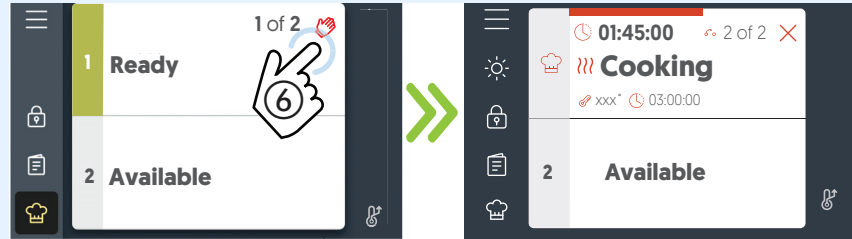

At the end of the cooking stage, the oven sounds an alert, and automatically switches to the holding stage if this stage was programmed into the recipe.

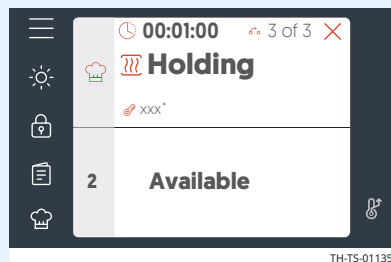

Result

The food is now cooked and is holding.

How to Cook and Hold by Time in Manual Mode

Before you begin

- Be sure your food is prepared and ready to cook.
- Be sure your oven is turned on.

Procedure

To cook and hold in manual mode, do the following.

Step	Action
1.	<p>Touch the professional cook icon ① if necessary to get to the manual cook screen.</p> <p>Touch the desired cavity ②.</p>  <p style="text-align: right;"><small>TH-TS-007392</small></p>
2.	<p>Touch the Preheat icon ③.</p>  <p style="text-align: right;"><small>TH-TS-008879</small></p>
3.	<p>Touch the preheat temperature ④. Enter a preheat temperature using the number pad ⑤. Touch the check mark ⑥.</p> <p>Touch the "+" ⑦ to add the cooking stage.</p>  <p style="text-align: right;"><small>TH-TS-011346</small></p>

Continued on next page

Continued from previous page

Set the cook

4. **Touch** the Cook icon ⑧. **Touch** the time icon ⑨

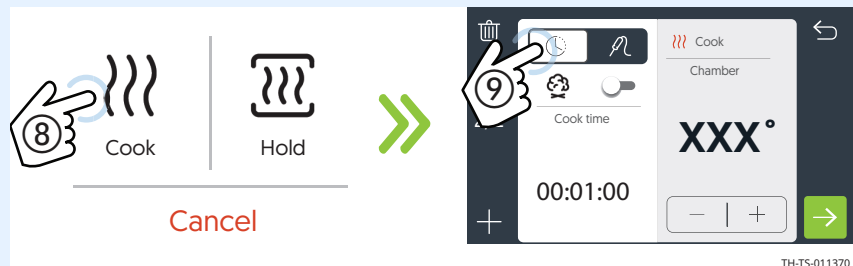

TH-TS-011370

5. **Touch** the cooking temperature ⑩. **Enter** the cooking temperature using the number pad ⑤. **Touch** the check mark ⑥.



TH-TS-011372

6. **Touch** the cooking time ⑪. **Enter** the cooking time using the number pad ⑤. **Touch** the check mark. ⑥
- Touch** the plus (+) icon ⑫ to add the holding stage.



TH-TS-011374

Continued on next page

Continued from previous page

Set the hold

7. **Touch** the Hold icon (13). **Touch** the hold by temperature icon (14).

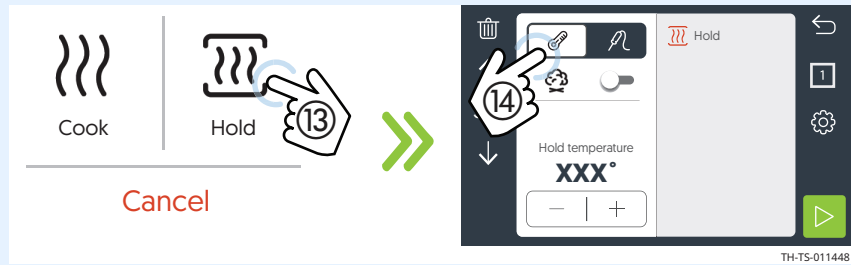

TH-TS-011448

8. **Touch** the holding temperature (15). **Enter** a holding temperature using the number pad (5). **Touch** the check mark (6).

Touch the green arrow (16). The preheat stage starts.

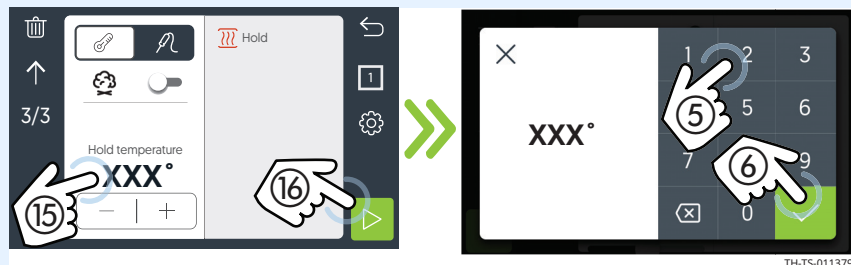

TH-TS-011379

Load the oven

9. At the end of the preheat stage, the oven sounds an alert, and the control will display "Ready". **Load** the food into the oven. **Touch** the action hand (17). The cooking process starts. **Touch** the "X" to cancel the cook if necessary.

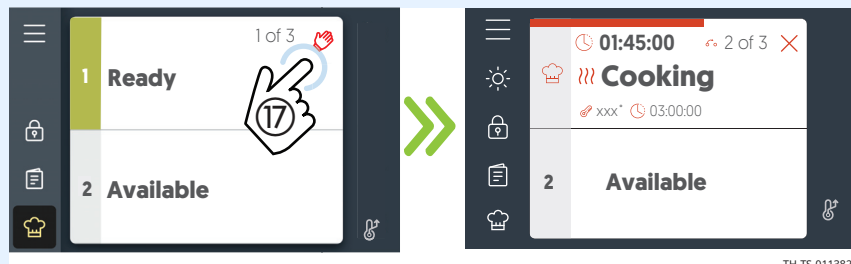

TH-TS-011382

At the end of the cooking stage, the oven sounds an alert, and automatically switches to the holding stage.

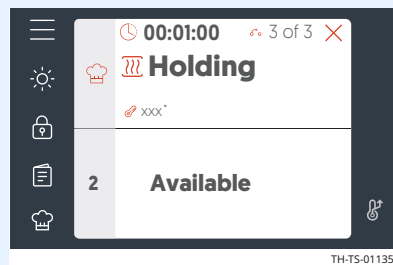

TH-TS-011350

Result

The food is now cooked and is holding.

Understanding the Probes

Background

Alto-Shaam Cook & Hold Ovens are capable of accommodating up to six (6) separate probes depending on the model.

The probe in the #1 position is the probe that is used when cooking and holding by probe. The probes in the other positions are used for gathering HACCP data.

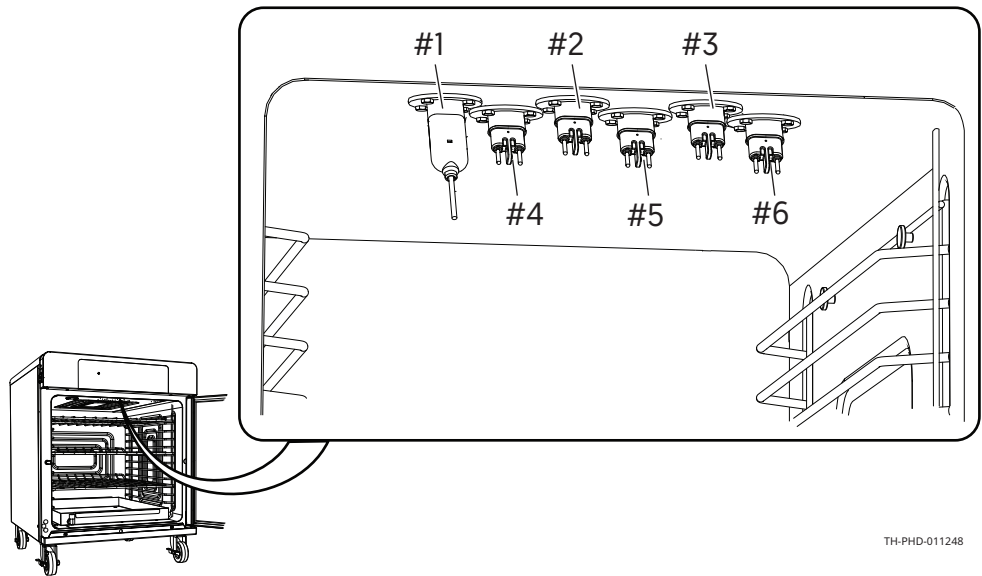

TH-PHD-011248



How to Cook by Probe in Manual Mode

Before you begin

- Be sure your food is prepared and ready to cook.
- Be sure your oven is turned on.

Procedure

To cook by probe, do the following.

Step	Action
1.	<p>Touch the professional cook icon ① if necessary to get to the manual cook screen.</p> <p>Touch the desired cavity ②.</p>  <p style="text-align: right; font-size: small;">TH-TS-007392</p>
2.	<p>Touch Preheat ③.</p>  <p style="text-align: right; font-size: small;">TH-TS-008879</p>
3.	<p>Touch the preheat temperature ④. Enter a preheat temperature using the number pad ⑤. Touch the check mark ⑥.</p> <p>Touch the "+" ⑦ icon to add the cooking stage.</p>  <p style="text-align: right; font-size: small;">TH-TS-007266</p>

Continued on next page

Continued from previous page

Set the cook

4. **Touch** the Cook icon (8). **Touch** the probe icon (9).

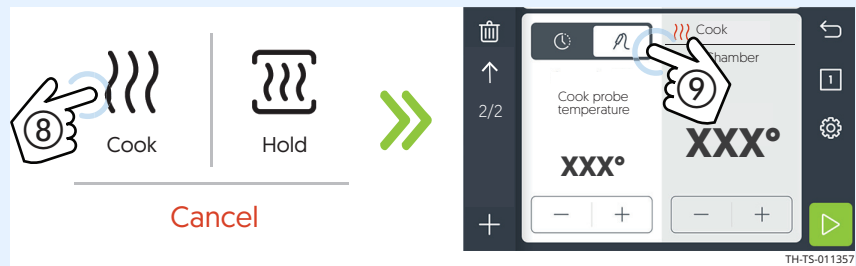

5. **Set** the desired temperature the food should cook to. To do so, **Touch** the probe set temperature (10). **Enter** a probe set temperature using the number pad (5). **Touch** the check mark (6).



6. **Set** the desired temperature of the cavity. To do so, **touch** the cook temperature (11). **Enter** a cook temperature using the number pad (5). **Touch** the check mark (6).

Touch the plus (+) icon (12) to add the holding stage.

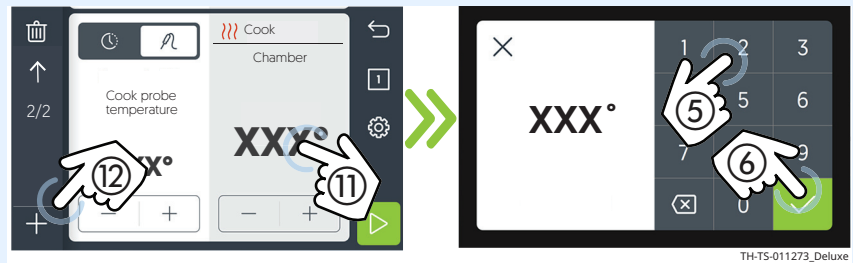

Continued on next page

Continued from previous page

Set the hold

7. **Touch** the Hold icon **13**. **Touch** the probe icon **14**.

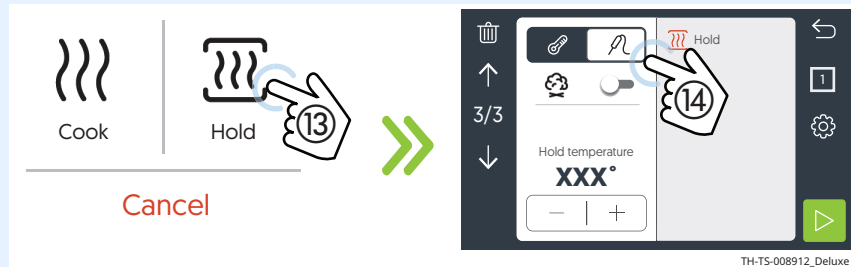

8. **Enter** the temperature you want the food to hold at. To do so, **Touch** the holding temperature **15**. **Enter** a holding temperature using the number pad **5**. **Touch** the check mark **6**.

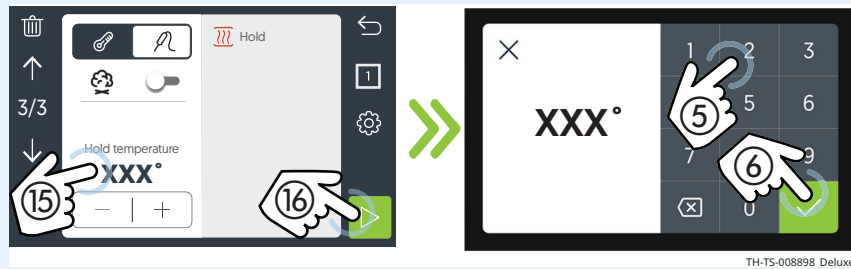

Touch the green arrow **16**. The oven will begin to preheat.

Load the food

9. At the end of the preheat stage, the oven sounds an alert, and the control will display "Ready". **Load** the food into the oven and **insert** the probe. **Touch** the action hand **17**. The cooking process starts. **Touch** the "X" icon **18** to cancel the cooking process if needed.

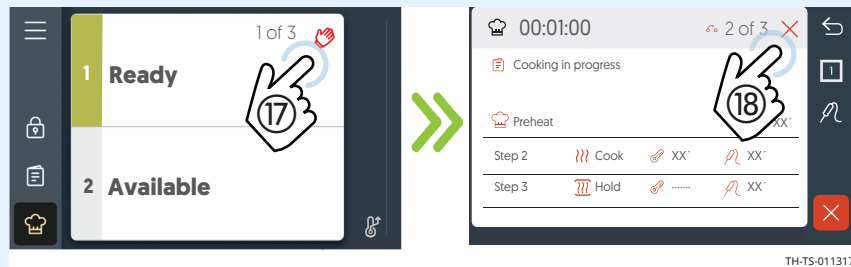

Continued on next page

Continued from previous page

10. At the end of the cooking stage, the oven sounds an alert, and automatically switches to the holding stage.

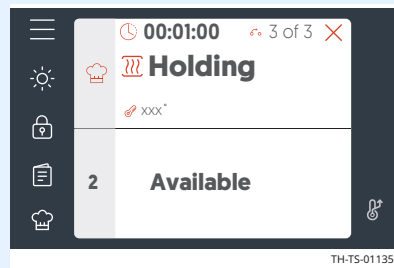

Result

The food is now cooked and is holding.

How to Hold by Probe

Before you begin

Make sure:

- The oven is preheated.
- Your food is fully cooked and hot.
- Fully cooked food is loaded into the oven.
- Probe is inserted into the food.

Procedure

To hold by probe, do the following.

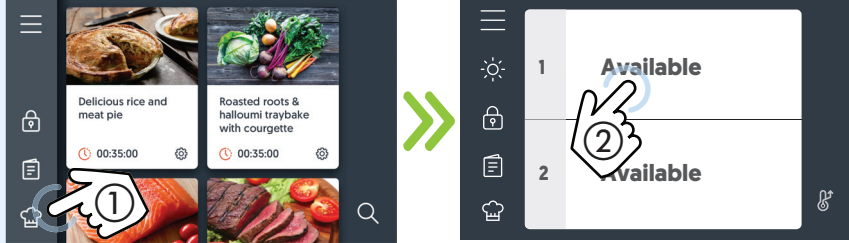
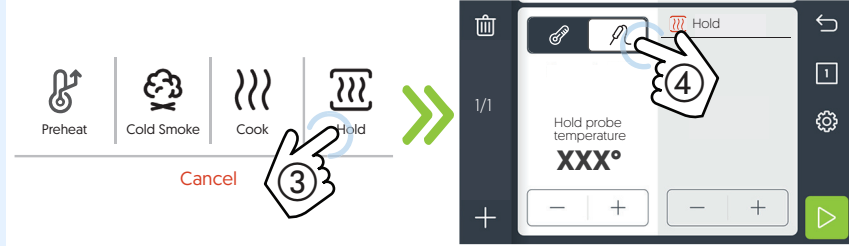
Step	Action
1.	<p>Touch the professional cook icon ① if necessary to get to the manual cook screen.</p> <p>Touch the desired cavity ②.</p>  <p style="text-align: right; font-size: small;">TH-TS-007392</p>
2.	<p>Touch Hold ③. Touch the hold by probe icon ④.</p>  <p style="text-align: right; font-size: small;">TH-TS-011388</p>

Continued on next page

Continued from previous page

3. **Touch** the hold temperature ⑤. **Enter** the holding temperature using the number pad ⑥. **Touch** the check mark ⑦.



4. **Touch** the green arrow ⑧. Holding begins.

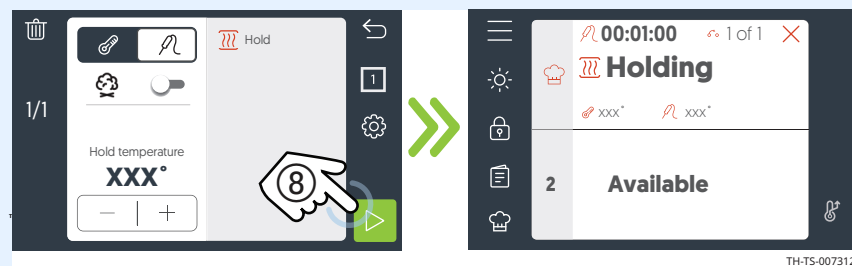

Result

The oven is holding by probe.

How to Prepare the Smoker Box for Smoking

Before you begin

- Use only wood chips supplied by Alto-Shaam.
- Clean the smoker box of used wood chips. Dispose of the burnt wood chips as directed by local codes.

Procedure

To prepare the smoker box for smoking, do the following.



WARNING: Fire hazard.

The use of improper materials for the smoke function can result in a fire which may lead to personal injury or property damage.

Only use wood chips supplied by Alto-Shaam.

Step	Action
1.	<p>Soak the wood chips in the clean water as instructed by National Fire Protection Agency Standard NFPA-96 or local codes. As of 2021, the NFPA-96 standard calls for a soaking period of 24 hours.</p> <div style="border: 1px solid orange; padding: 5px; margin-top: 10px;">  <p>WARNING: Fire hazard. Soaking the wood chips in anything besides clean water may lead to personal injury or property damage. Only soak the wood chips in clean water.</p> </div>
2.	<p>Shake off excess water and place the moistened chips in the smoker box. Close the smoker box lid.</p>
3.	<p>Slide the smoker box over the smoker element so that it rests in the cradle.</p> <div style="display: flex; justify-content: space-around; align-items: center;">   </div> <p style="text-align: right; font-size: small;">TH-TS-011284</p>

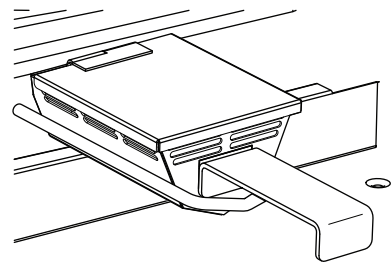
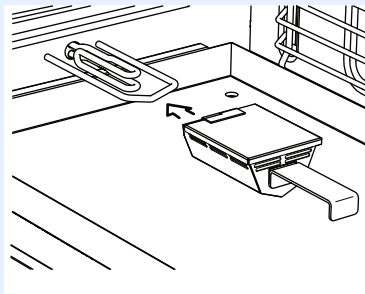

TH-TS-011284

Result

The smoker box is now prepared for smoking.

How to Hot Smoke in Manual Mode

Background

When hot smoking, the smoking function is designed to be enabled (turned ON) at the start of the first cooking stage. The smoking function default time is 90 minutes. This means that the smoking process can run over into the holding stage if the cooking stage is shorter than 90 minutes and smoking is turned on during the holding stage.

Before you begin

Make sure:

- Your food is prepared and ready to smoke.
- The wood chips have been soaked and the smoker box has been prepared for smoking. See topic *How to Prepare the Smoker Box for Smoking*.



WARNING: Fire hazard.

The use of improper materials for the smoke function can result in a fire which may lead to personal injury or property damage.

Only use wood chips supplied by Alto-Shaam.

Procedure

To hot smoke in manual mode, do the following.

Step Action

1. **Touch** the professional cook icon ① if necessary to get to the manual cook screen.

Touch the desired cavity ②.

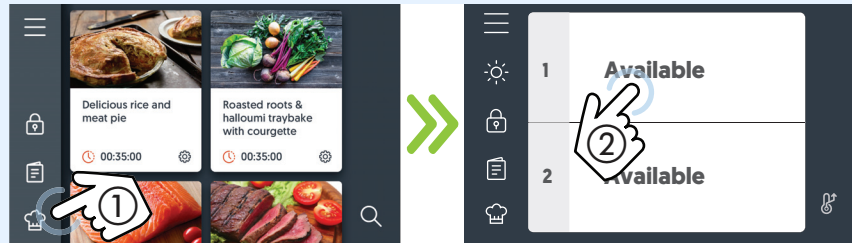

TH-TS-007392

Set the preheat

2. **Touch** the Preheat icon ③.



TH-TS-008879

Continued on next page

Continued from previous page

3. **Touch** the preheat temperature ④. **Enter** a preheat temperature using the number pad ⑤. **Touch** the check mark ⑥.
Touch the "+" ⑦ to add the cooking stage.



TH-TS-007266

Set the cook

4. **Touch** the Cook icon ⑧. **Slide** the smoke button ⑨ to the ON position. This enables the smoking function. It will start when the cooking stage starts and remain on for 90 minutes. If a shorter smoke time is desired, set this cooking stage to the time you want to smoke, then add a second cooking stage to continue the cooking process.

Touch the time icon ⑩.

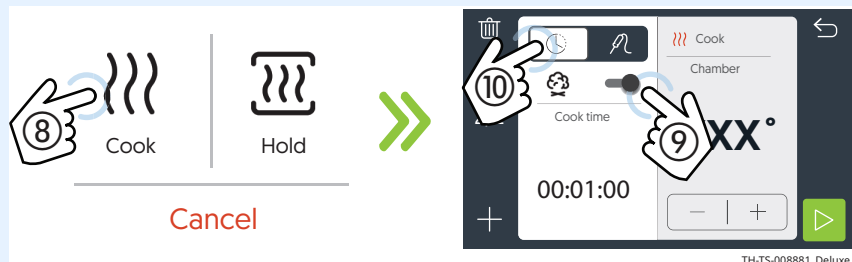

TH-TS-008881 Deluxe

5. **Touch** the cooking time ⑪. **Enter** the cooking time using the number pad. **Touch** the check mark.

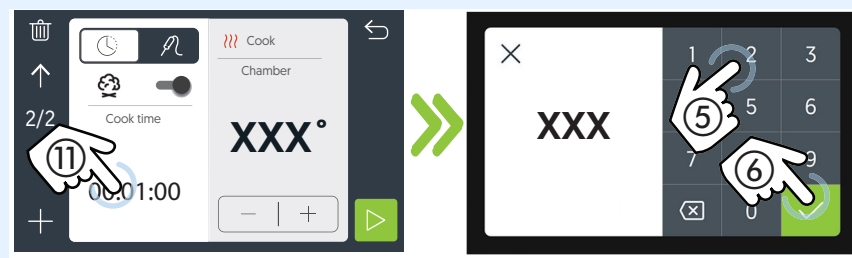

TH-TS-011242 Deluxe

Continued on next page

Continued from previous page

6. **Touch** the cooking temperature (12). **Enter** the cooking temperature using the number pad (5). **Touch** the check mark (6).

Touch the "+" (13) to add the holding stage.

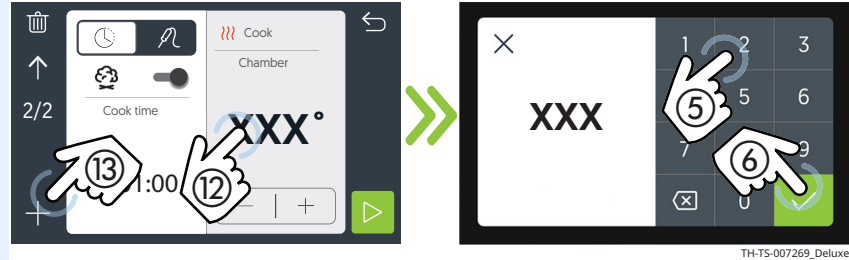

Set the hold

7. **Touch** the Hold icon (14).

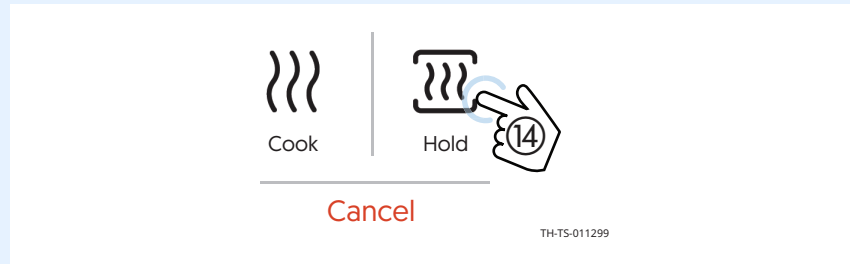

8. **Touch** the holding temperature (17). **Enter** a holding temperature using the number pad. **Touch** the check mark.

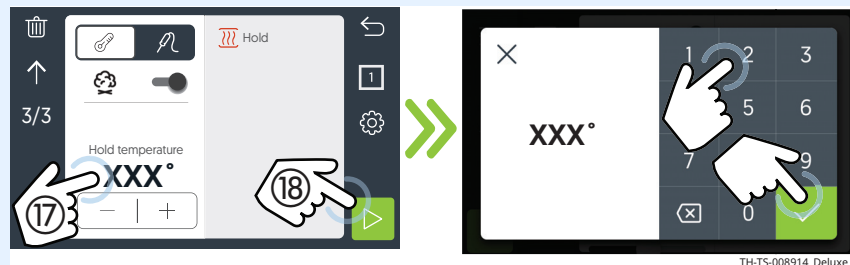

Start the preheat

Touch the green arrow (18). The oven begins to preheat.

At the end of the preheat stage, the oven sounds an alert, and the control displays "Ready".

Continued on next page

Continued from previous page

Load the food

9. **Load** the food into the oven. **Touch** the action hand **19**. The cooking process starts.

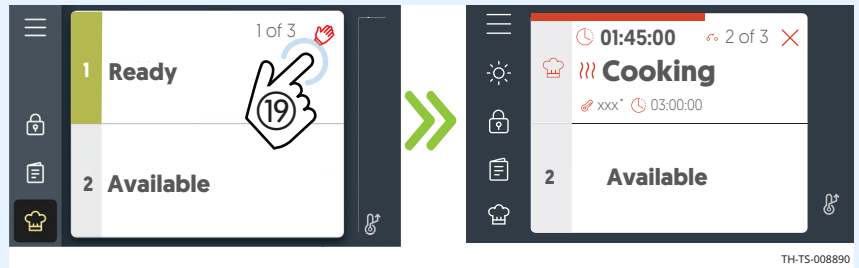

At the end of the cooking stage, the oven sounds an alert, and automatically switches to the holding stage.

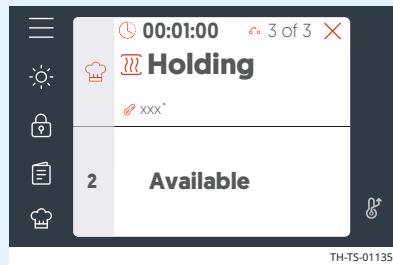

Result

The food is now cooked and smoked.

How to Cold Smoke

Before you begin

Make sure:

- Your food is prepared and ready to smoke.
- The wood chips have been soaked and the smoker box has been prepared for smoking. See topic *How to Prepare the Smoker Box for Smoking*.



WARNING: Fire hazard.

The use of improper materials for the smoke function can result in a fire which may lead to personal injury or property damage.

Only use wood chips supplied by Alto-Shaam.

Procedure

To cold smoke, do the following.

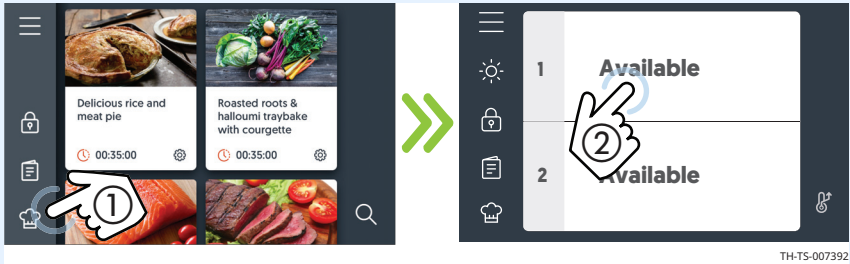
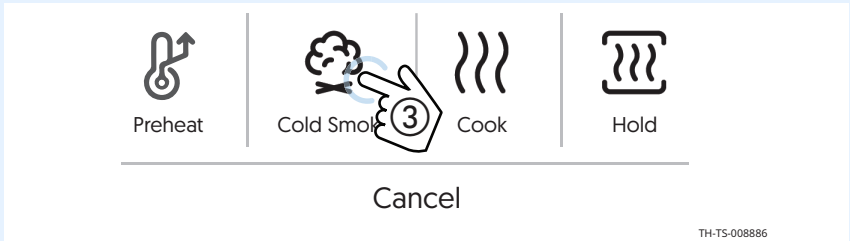
Step	Action
1.	<p>Touch the professional cook icon ① if necessary to get to the manual cook screen.</p> <p>Touch the desired cavity ②.</p>  <p style="text-align: right; font-size: small;">TH-TS-007392</p>
2.	<p>Touch Cold Smoke ③.</p>  <p style="text-align: right; font-size: small;">TH-TS-008886</p>

Set the smoke

Continued on next page

Continued from previous page

3. **Touch** the cold smoke time ④.
Enter a cold smoke time on the using number pad — 10 to 90 minutes ⑤.
Touch the green arrow ⑥.

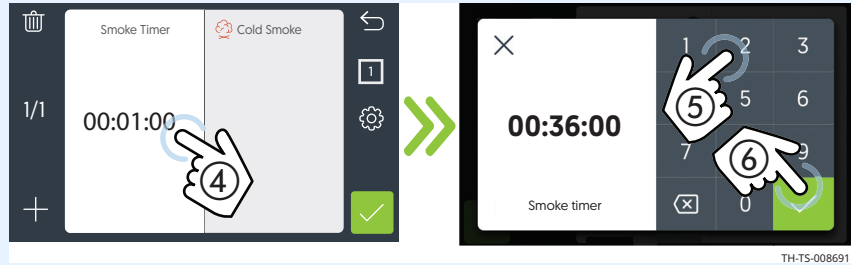

Load the food

4. The “Ready” screen is displayed. **Load** food into the oven and close the oven door. Keep the oven door closed throughout the smoking process.
Touch the action hand icon to start the cold smoking process ⑦.

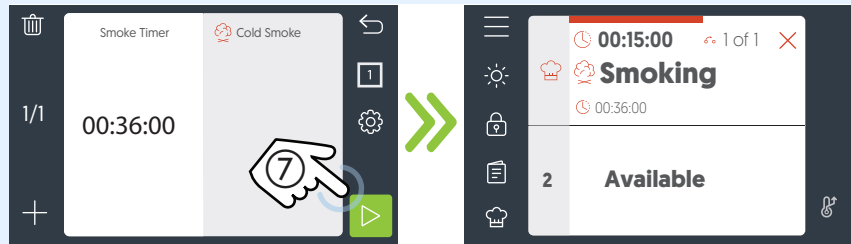

If needed, **touch** the “X” icon to cancel the smoking process.
 The screen indicates the time remaining in the smoke cycle.

Result

The oven is cold smoking.

How to Create a Recipe

Before you begin

- If smoking, **see** topic *Preparing the Smoker Box for Smoking*.
- **Make sure** you are familiar with the oven operation and have read the topic *How to Cook and Hold in Manual Mode*.

Procedure

To create a recipe, do the following.

Step	Action
------	--------

1. **Touch** the recipes icon ①.

Touch the plus icon to add a recipe ②.

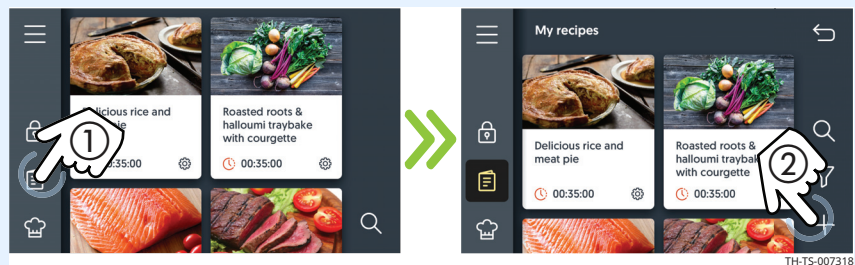

2. **Enter** the settings ③ for the following:

- Preheat temperature
- Cooking time and temperature
- Holding time and temperature
- Probe temperature
- Smoking ON or OFF

Touch the green arrow ④ when finished to save the recipe.

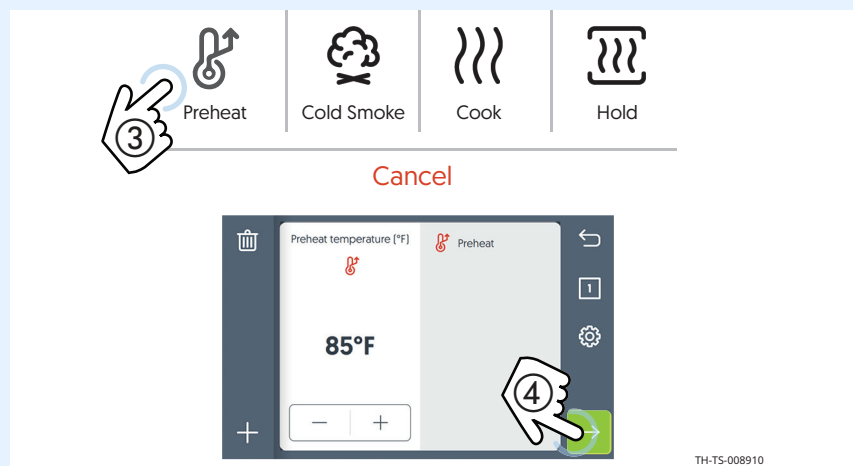

Continued on next page

Continued from previous page

3. **Enter** the recipe name using the key pad ⑤ if desired.
Touch the green arrow ⑥ to save the name.



4. **Enter** the recipe description using the key pad ⑦ if desired.
Touch the green arrow ⑧ to save the recipe description.



5. **Touch** the check box ⑨ to assign the recipe to a category or categories if desired.
Touch the green arrow ⑩ to save the recipe to a category.

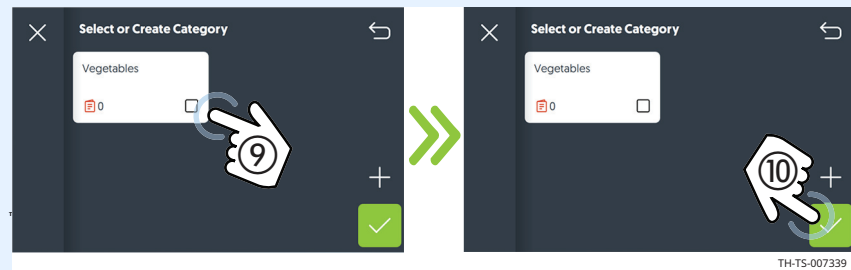

Continued on next page

Continued from previous page

6. **Touch** the check box ⑪ to select a cover photo if desired.
Touch the green arrow ⑫ to save the cover photo.

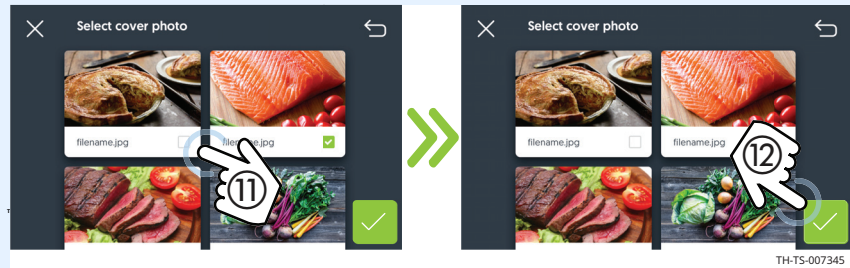

7. **Touch** the check box ⑬ to add photo to the gallery if desired.
Touch the green check mark ⑭ to add the photo to the gallery.

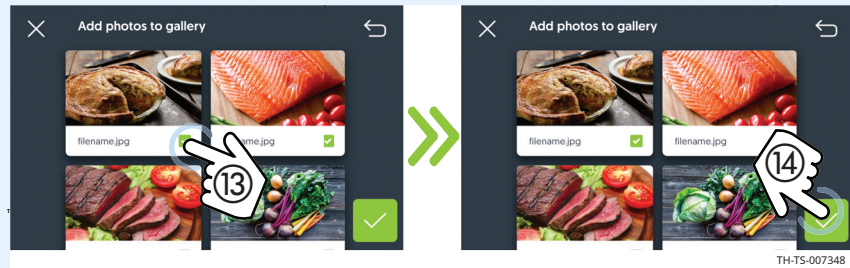

Result

A recipe has been created.

How to Modify, Duplicate, or Delete a Recipe

Procedure

To modify, duplicate, or delete a recipe, do the following.

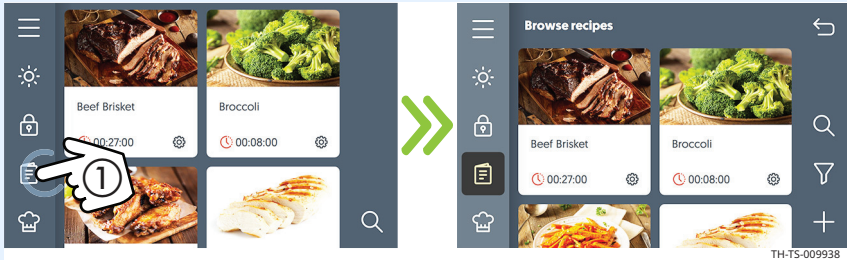
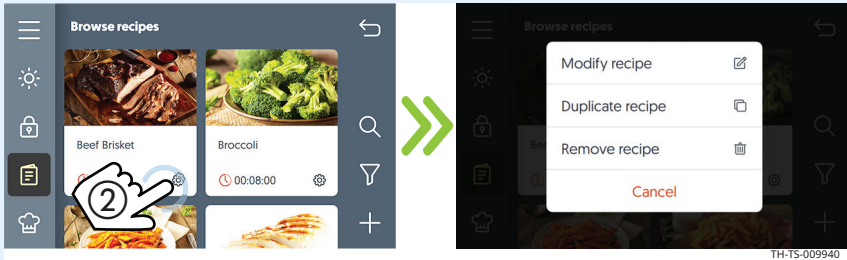
Step	Action
1.	<p>Touch the recipes icon ①. The browse recipes screen displays.</p> 
2.	<p>Touch the recipe settings icon ② of the desired recipe.</p> <p>Touch Modify recipe to edit a recipe.</p> <p>Touch Duplicate recipe to copy a recipe.</p> <p>Touch Remove recipe to delete a recipe.</p> 

Result

The procedure is now complete.

How to Load Recipes from a USB Drive

Before you begin

You will need a USB drive loaded with recipes.

Procedure

To load recipes from the USB drive to the oven, do the following.

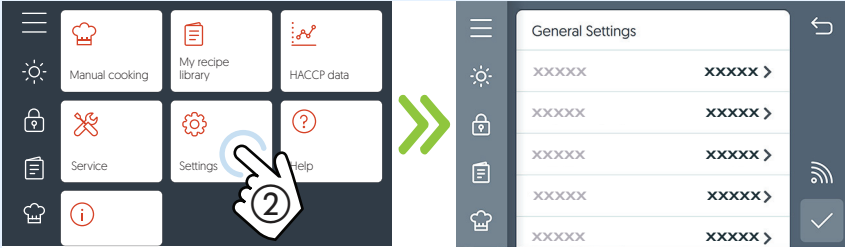
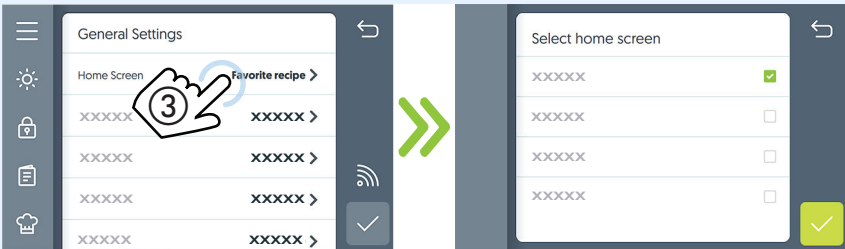
Step	Action
1.	<p>Touch the menu icon ①. The menu screen displays.</p>  <p>TH-TS-009945</p>
2.	<p>Touch the Settings icon ②. The general settings screen displays.</p>  <p>TH-TS-009947</p>
3.	<p>Plug the USB drive ③ into the port.</p>  <p>TH-TS-009974</p>

Continued on next page

Continued from previous page

4. **Scroll** to System Backup & Update.
Touch the Upload recipes from USB ④ setting.

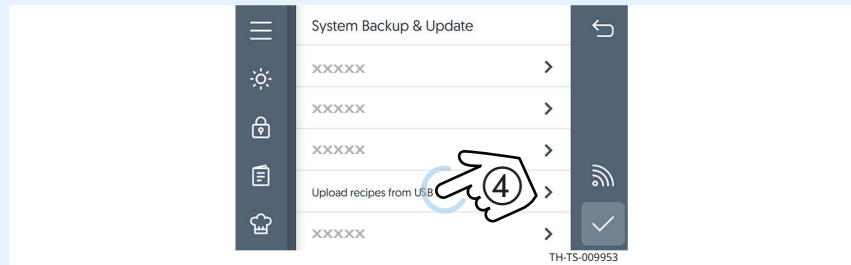

Loading the recipes

The oven loads the recipe file. When the process is complete, the Recipes uploaded screen displays. **Touch** the green check mark to return to the settings screen. **Remove** the USB drive.

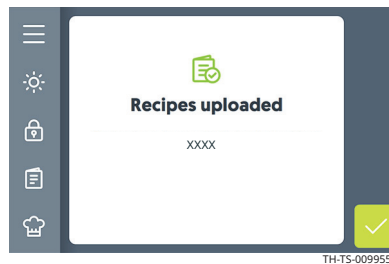

Result

The recipes are now loaded.

How to Save Recipes to a USB Drive

Before you begin

You will need a USB drive.

Procedure

To save recipes from the oven to a USB drive, do the following.

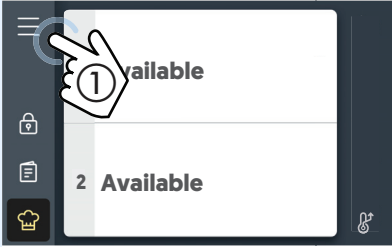
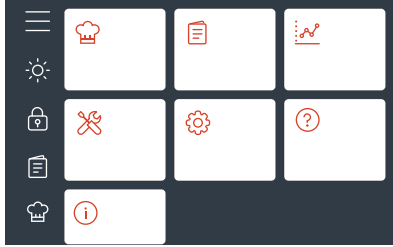
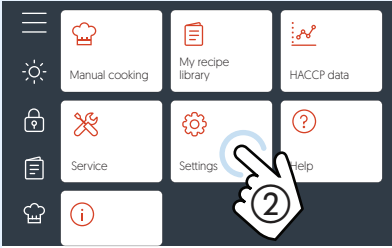
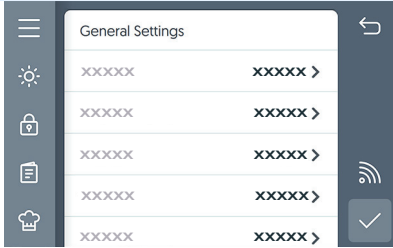
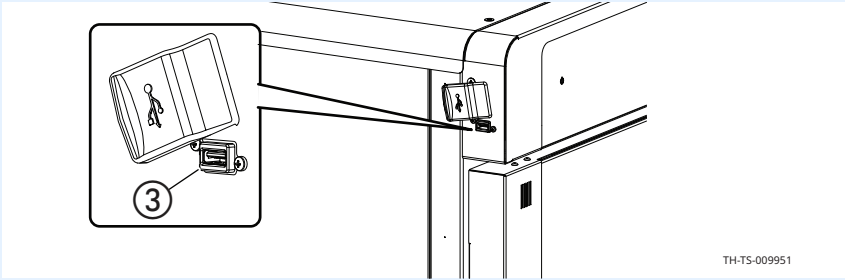
Step	Action
1.	<p>Touch the menu icon ①. The menu screen displays.</p>   <p style="text-align: right;"><small>TH-TS-009945</small></p>
2.	<p>Touch the Settings icon ②. The general settings screen displays.</p>   <p style="text-align: right;"><small>TH-TS-009947</small></p>
3.	<p>Plug the USB drive into the port ③.</p>  <p style="text-align: right;"><small>TH-TS-009951</small></p>

Continued on next page

Continued from previous page

4. **Scroll** to System Backup & Update.
Touch the Download recipes to USB **4** setting.



Loading the recipes

The oven downloads the recipes onto the USB drive. When the process is complete, the Recipes downloaded screen displays. **Touch** the green check mark to return to the settings screen. **Remove** the USB drive.

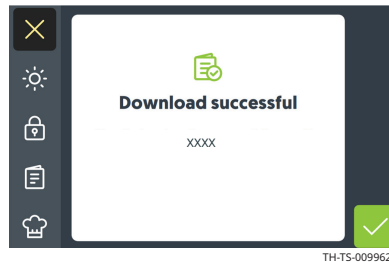

Result

The recipes are now saved to the USB drive.

How to Update Software with a USB Drive

Before you begin

- You will need a USB drive with the updated software. To download the most up to date oven software and register for email notifications when new software versions are released, please visit <https://www.alto-shaam.com/en/customer-support/software-downloads>.
- Do not remove the USB drive during the update process.

Procedure

To update the software, do the following.

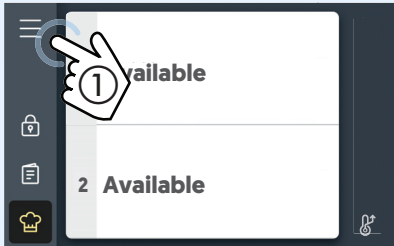
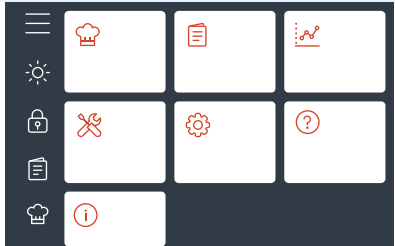
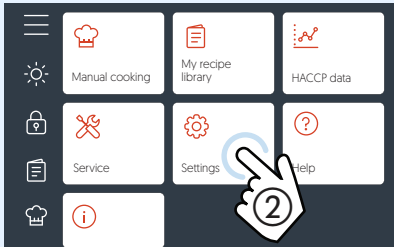
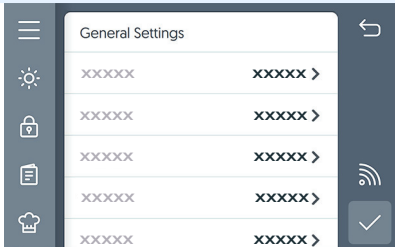
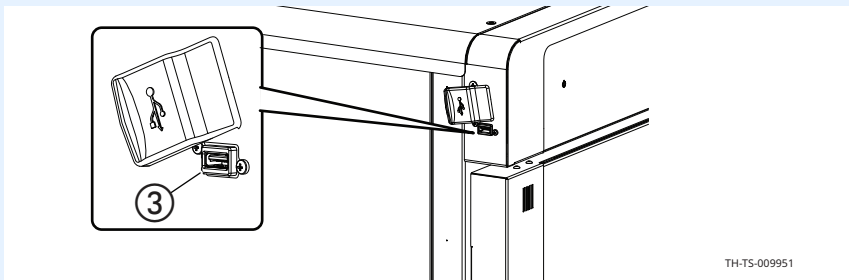
Step	Action
1.	<p>Touch the menu icon ①. The menu screen displays.</p>   <p style="text-align: right;">TH-TS-009945</p>
2.	<p>Touch the Settings icon ②. The general settings screen displays.</p>   <p style="text-align: right;">TH-TS-009947</p>
3.	<p>Plug the USB drive into the port ③.</p>  <p style="text-align: right;">TH-TS-009951</p>

Continued on next page

Continued from previous page

4. **Scroll** to System Backup & Update.

Touch the Update system software ④ setting.



Touch Control Board (CB) to update the control board. The oven loads the selected software. The oven verifies the file and then updates the CB.

NOTICE Do not remove the USB drive during the update process.

Touch Front End to update the user interface software. The oven loads the selected software.

Touch Back End to update the supporting software between the control board (CB) and interface board (IB). The oven loads the selected software.

5. **Touch** the green check mark when the update is complete to restart the oven.



6. **Remove** the USB drive.



Result

The software has now been updated.

How to Change Settings

Procedure

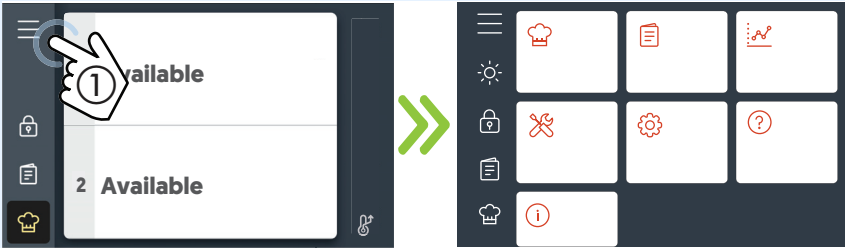
To change settings, do the following.

Step	Action
1.	<p>Touch the menu icon ①. The menu screen displays.</p> 
2.	<p>Touch the Settings icon ②.</p> 

Settings

Here you can change the following settings:

Category	Settings
General Settings	Home Screen defaults
	Language
Date and Time Settings	Timezone
	Network Time
Sound & Light Alerts	Alarm Volume
	Light brightness
	Alarm Volume
Temperature Settings	Temperature Units
	Default preheat temperatures
Probes Offset	Chamber 1 and 2 probes
System Backup & Update	Backup system to USB
	Restore system from USB
	Download recipes to USB

Category	Settings
	Upload recipes from USB
	Upload system software
Security Locks	Lock recipe editing
	Lock manual cooking
	Lock settings screen
Connections Settings	SSID
	IP
	MAC
	Install certificates
Network Status	Connection type
	Internet
	Cloud
	Update Server

Result

The settings have been changed.

How to View Oven Information



Background

Oven information is viewable only through the touchscreen on the Deluxe control, not through the ChefLinc™ oven management system.

The oven information screen shows the system information, serial number, network status, connection settings, and cleaning timer.

Procedure

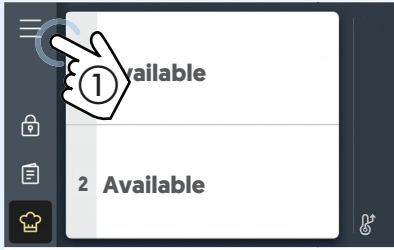
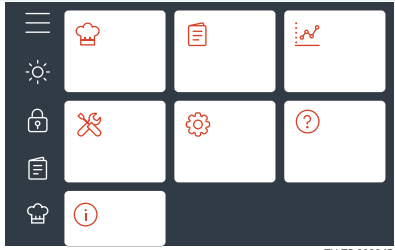
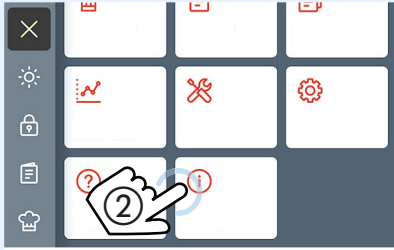
To view oven information, do the following.

Step	Action
1.	<p>Touch the menu icon ①. The menu screen displays.</p>   <p style="text-align: right; font-size: small;">TH-TS-009945</p>
2.	<p>Touch the Info page icon ②. The oven information screen displays.</p> <p>Scroll to view the oven model, serial number, system software, network status, and cleaning timer.</p>   <p style="text-align: right; font-size: small;">TH-TS-009988</p>

Result

The oven's information has been viewed.

How to Download HACCP Data

Before you begin

You will need a USB drive.

Background

HACCP data provides automated record keeping, set-point validation, recipes used, dates and times. The data is stored until the information is downloaded. Once downloaded, the information is removed from the oven's memory. Best practice would be to download the information every 30 days to a USB drive. The file format is plain text file (.csv). The file can be viewed in Microsoft® Excel.

Procedure

To download HACCP data, do the following.

Step	Action
1.	<p>Touch the menu icon ①. The menu screen displays.</p>  <p style="text-align: right; font-size: small;">VMC-TS-006259</p>
2.	<p>Touch the HACCP data icon ②. The HACCP data screen displays.</p>  <p style="text-align: right; font-size: small;">VMC-TS-008644</p>

Continued on next page

Continued from previous page

3. **Plug** the USB drive into the port ③.

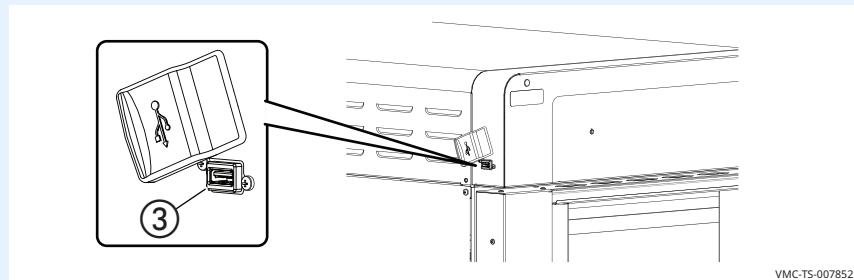

4. **Touch** the download icon ④.

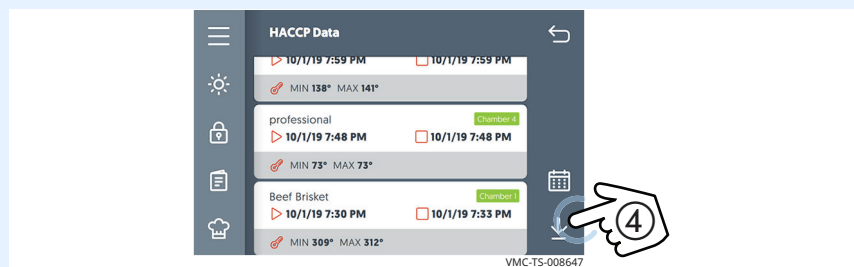

Loading the data

The oven downloads the data onto the USB drive. When the process is complete, the download successful screen displays. **Touch** the check mark to return to the menu screen. **Remove** the USB drive.

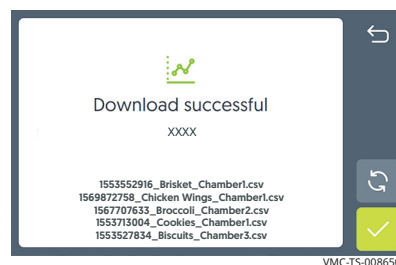

Result

The HACCP data has now been downloaded.

How to Calibrate the Temperature Probe

Before you begin

Make sure:

- The oven is on, but not in cooking or holding mode.
- You have a thermometer.
- You have a container filled with ice and water.

Procedure

To calibrate the probe, do the following.

Step	Action
1.	Place the probe and the thermometer in a container of ice water and allow the temperature to settle to 32°F (0°C).
2.	Touch the menu icon ①. The control displays the menu screen. <div style="text-align: center;">  ➤➤  </div>
3.	Touch the Settings icon ②. The control displays the General Settings screen. <div style="text-align: center;">  ➤➤  </div>

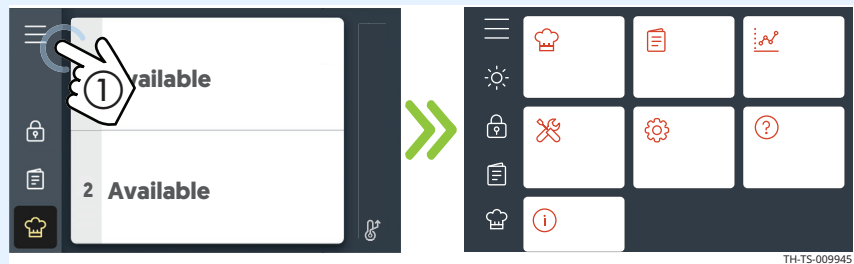

TH-TS-009945

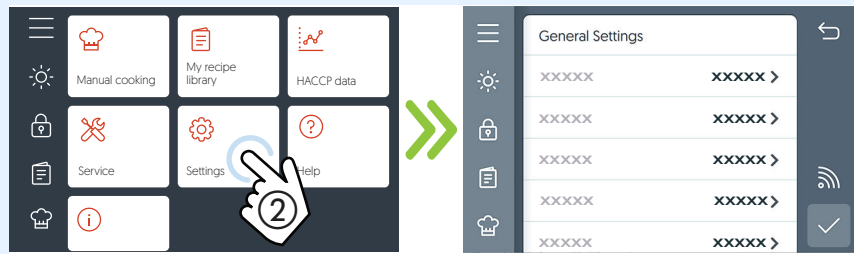

TH-TS-009947

Continued on next page

Continued from previous page

4. **Scroll** ③ until "Probes Offsets" displays. **Touch** the ">" icon ④.

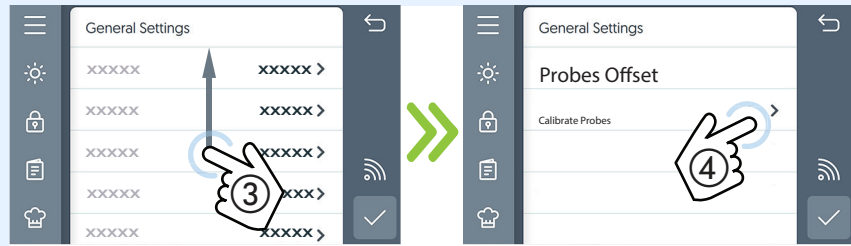

5. **Compare** the probe temperature reading against 32°F (0°C).

Touch the "+" or "-" symbols until the temperature displayed is 32°F (0°C) ⑤.

Touch the green check mark ⑥.

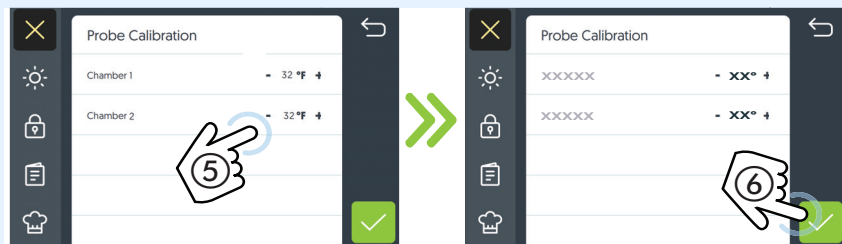

6. **Remove** the probe from the ice water.

7. If the oven has multiple probes, repeat this procedure until all probes are calibrated.

Result

The probe is now calibrated.

This page intentionally left blank.

Maintenance Schedule

Requirements

- See topic *How to Clean the Oven*.
- Make sure the oven is cooled down and off—inside of chamber 140°F (60°C) or less.

Daily

For daily maintenance, do the following.

- See topic *How to Clean the Oven*, and follow the Daily Cleaning procedure.
- **Check** the screen for cracking or peeling. Contact Technical Service if needed.

Weekly

For weekly maintenance, do the following.

- See topic *How to Clean the Oven*, and follow the Weekly Cleaning procedure.
- **Check** the oven for any damage or loose parts.

Monthly

For monthly maintenance, do the following.

- **Inspect** door gasket.
- **Inspect** door window gasket for proper seal.
- **Inspect** cavity door vent slides for proper operation.
- **Inspect** side racks, shelves, and shelf supports for damage.
- **Calibrate** the removable product probe (if applicable)
- **Clean** the cooling fan intake area and exhaust vents.
- **Inspect** door handle screws and tighten if necessary.
- **Inspect** the smoke element (if applicable). If any deformation, cracks or breaks are seen, remove the oven from service and contact a factory authorized service technician.

Yearly

For yearly maintenance, do the following.



NOTE: Must be performed by a qualified professional.

- **Check and tighten** all wire connections.
- **Inspect** the smoke element and smoke element wiring.
- **Measure** the current draw of each cavity. Operate with smoker on if applicable.
- **Test** the heating elements for electrical short to ground.
- **Inspect** the condition of the cord and plug.

Continued on next page

Continued from previous page

- **Check and tighten** the cord connection inside of the appliance control area.
 - **Inspect** the control cooling fans (if applicable).
 - **Measure** the site voltage.
 - **Inspect and adjust** voltage monitor board if needed.
 - **Inspect** and test the product probe and product probe receptacle.
 - **Inspect** and test the control and control functions.
-
- **Inspect** the cavity for structural integrity.
 - **Inspect** the door gaskets for correct shape and seal. Replace/repair as needed.
 - **Inspect** the door handle and hinges. Replace/repair as needed.
 - **Inspect** the full perimeter bumper.
 - **Inspect** the casters.
 - **Do** a cavity temperature calibration procedure per manufacturer's recommendations.

How to Clean the Oven

Before you begin



WARNING: Electric shock hazard.
Set the power switch to the OFF position and unplug the oven before cleaning it.



CAUTION: Burn hazard.
Allow the oven, drip pans, and racks to cool before cleaning.



CAUTION: Corrosive materials hazard.
Wear eye protection and hand protection when cleaning.

NOTICE

Using improper cleaning procedures will damage the oven and void the warranty.
Only use spray cleaner when the electric power is completely removed from the oven.
Do not use steel pads, wire brushes, or scrapers when cleaning.

Daily cleaning procedure

To clean the oven daily, do the following.

Step	Action
1.	Make sure the oven is turned off and cool—cavity is less than 140°F (60°C).
2.	Remove any all detachable items such as wire shelves, side racks, drip pan, and drip tray and clean these items separately.
3.	Remove any spills with disposable paper wipes or a damp cloth.
4.	Wipe the outside of the oven and the drip tray holder with a damp cloth.
5.	Wipe the control panel, door vents, door handles and door gaskets with a non-abrasive nylon scrub pad.
6.	If oven has an optional glass door, clean each side of the window pane with an all-purpose glass cleaner.
7.	Wipe probe, cable assembly, and probe prongs with a non-abrasive nylon scrub pad. Wipe probes with disposable alcohol pad or sanitizing solution recommended for food contact surfaces.
8.	Wipe the outside of the oven with a stainless steel cleaner.

Continued on next page

Continued from previous page

Weekly cleaning procedure

To clean the oven weekly, do the following.

Step	Action
1.	Set the power switch to the OFF position and unplug the appliance.
2.	Wipe the exterior areas of the oven with a non-abrasive nylon scrub pad.
3.	Spray the exterior areas of the oven with stainless steel polish.
	<div style="border: 1px solid blue; padding: 5px;"> <p>NOTICE Use only non-caustic cleaners. Do not spray directly into the fan openings on the back of the oven. Do not use cleaners that contain sodium hydroxide (lye) or phosphorus.</p> </div>
4.	Spray the interior areas of the oven with oven cleaner. Let the cleaner work for 3–5 minutes.
5.	Wipe the interior of the oven with a non-abrasive nylon scrub pad.
6.	Clean the door gasket with a warm water and detergent solution.
7.	If oven has an optional glass door, clean each side of the window pane with an all-purpose glass cleaner.
8.	Plug the appliance in and set the power switch to the ON position when complete.

Result

The oven is now clean.

Error Codes

DELUXE CONTROL			
Code	Description	Cause	Remedy
E-10	Cavity probe shorted	Short circuit detected on sensor wires.	1. Sensor connection 2. Sensor 3. Control Board
E-30	Unit under temperature	Cavity temperature remains 25°F (14°C) below target for more than 90 minutes.	Troubleshoot heating element
E-31	Unit over temperature	Cavity temperature is 50°F (28°C) above max allowable cook temperature of 325°F (163°C).	1. Cooling fan not operating 2. Installation clearance requirements not met
E-78	Under voltage	Supply voltage falls below 200V (error doesn't show on screen).	Correct the supply voltage
E-79	Over voltage	Supply voltage exceeds 250V (error doesn't show on screen).	Correct the supply voltage
E-94	Communication	No signal transfer for more than 5 seconds between the Interface Board and the Control Board.	1. Connection of Modbus Cable 2. Modbus Cable 3. Control Board 4. Interface Board
E-108	Check fans	Insufficient internal cooling airflow.	1. Cooling fan filters dirty 2. Cooling fans not operating 3. Installation clearance requirements not met
E-109	High Limit NOTE: Any oven experiencing this error should be investigated by an authorized Alto-Shaam service provider.	Open circuit detected across High Limit Switch	1.Heat Relay(s) stuck closed 2.Connection between High Limit Switch and Control Board 3.High Limit Switch

Cheflinc.alto-shaam.com is Not Available on Your Device

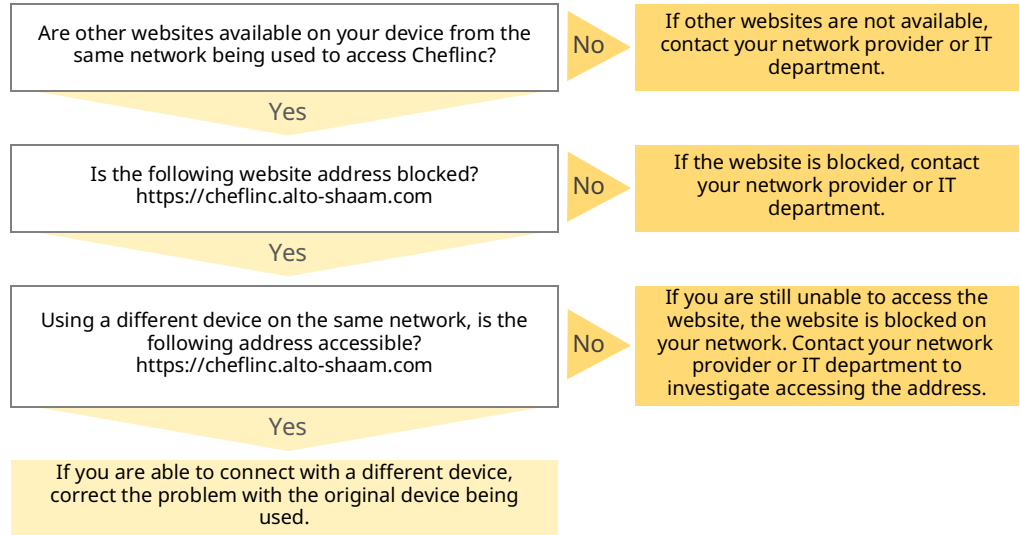

Cannot Connect to cheflinc.alto-shaam.com

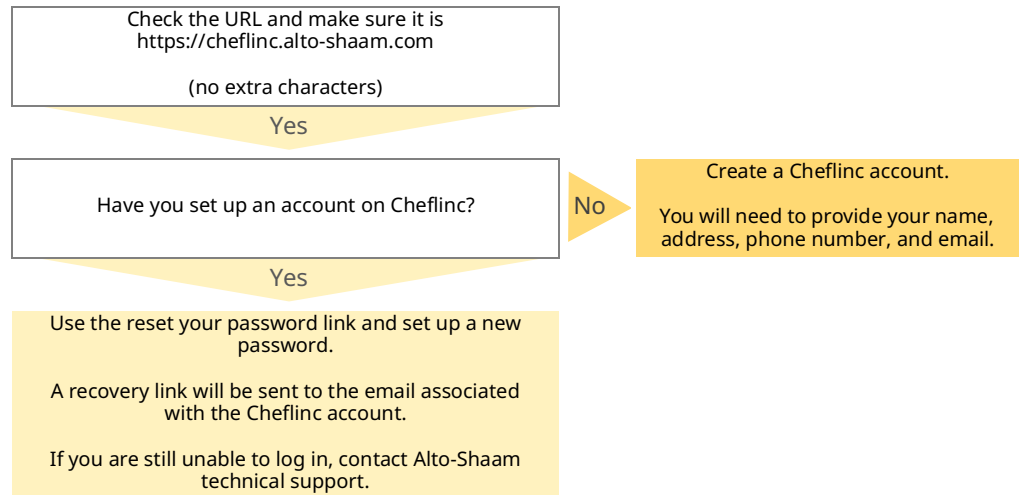

The Oven is not Displayed on the Dashboard

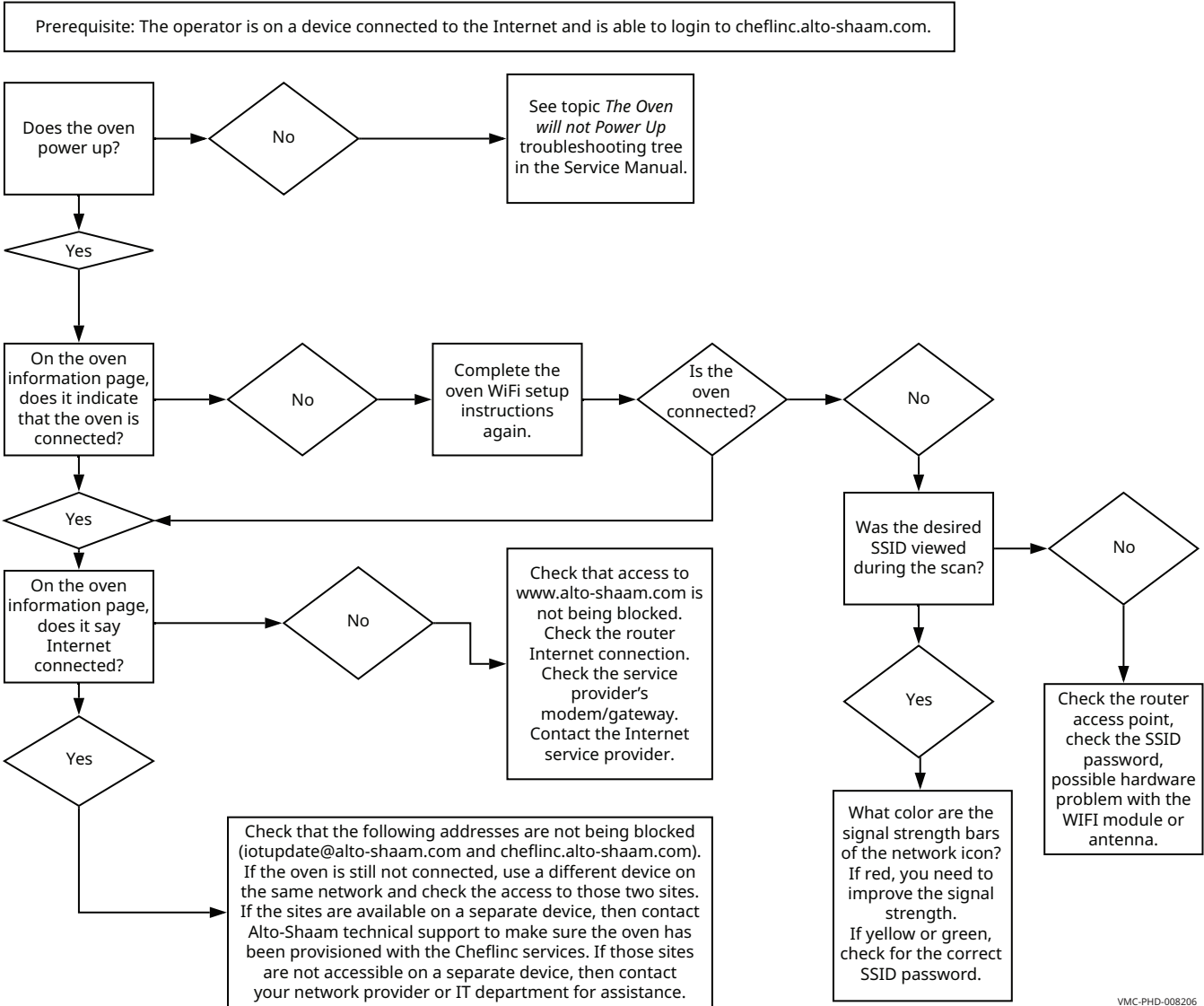

Unable to Assign Recipes from the Dashboard to Ovens in the Field

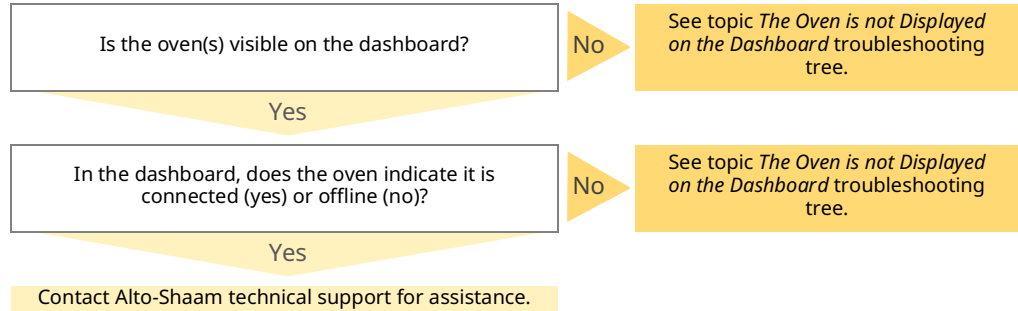

This page intentionally left blank.

Warranty

Introduction

Alto-Shaam, Inc. warrants to the original purchaser only, that any original part found to be defective in material or workmanship will be replaced with a new or rebuilt part at Alto-Shaam's option, subject to provisions hereinafter stated.

Warranty Period

The original parts warranty period is as follows:

- For all other original parts, one (1) year from the date of installation of appliance or fifteen (15) months from the shipping date, whichever occurs first.
- The labor warranty period is one (1) year from the date of installation or fifteen (15) months from the shipping date, whichever occurs first.
- Alto-Shaam will bear normal labor charges performed during standard business hours, excluding overtime, holiday rates or any additional fees.
- For the refrigeration compressor, if installed, the warranty period is five (5) years from the date of original installation of the appliance.
- For heating elements on Halo Heat® Cook and Hold ovens, the warranty period is for as long as the original owner owns the oven. This warranty period applies to units sold after 2/1/2009 and excludes holding-only ovens.
- To be valid, a warranty claim must be asserted during the applicable warranty period. This warranty is not transferable.

Exclusions

This warranty does not apply to:

- Calibration.
- Replacement of light bulbs, rubber gaskets, grease filters, air filters, racks, jet plates, and/or the replacement of glass due to damage of any kind.
- Equipment damage caused by accident, shipping, improper installation or alteration.
- Equipment used under conditions of abuse, misuse, carelessness or abnormal conditions, including but not limited to, equipment subjected to harsh or inappropriate chemicals, including but not limited to, compounds containing chloride or quaternary salts, poor water quality, or equipment with missing or altered serial numbers.
- Equipment damage caused by use of any cleaning agents other than those recommended by Alto-Shaam, including but not limited to damage due to chlorine or other harmful chemicals.
- Any losses or damage resulting from malfunction, including loss of food product, revenue, or consequential or incidental damages of any kind.
- Equipment modified in any manner from original model, substitution of parts other than factory authorized parts, unauthorized removal of any parts including legs, or unauthorized addition of any parts.

Continued on next page

WARRANTY

Continued from previous page

- Equipment damage incurred as a direct result of poor water quality*, inadequate maintenance of steam generators and/or surfaces affected by water. Water quality and required maintenance of steam generating equipment is the responsibility of the owner/operator.
 - Equipment damage incurred as a result of not following the required maintenance schedule published in the manuals for the equipment.
-

Conclusion

This warranty is exclusive and is in lieu of all other warranties, express or implied, including the implied warranties of merchantability and fitness for a particular purpose. No person except an officer of Alto-Shaam, Inc. is authorized to modify this warranty or to incur on behalf of Alto-Shaam any other obligation or liability in connection with Alto-Shaam equipment.

**Refer to the product spec sheet for water quality standards.*

DECLARATION OF CONFORMITY

Manufacturer:
Alto-Shaam, Inc.
W164 N9221 Water Street
Menomonee Falls, WI 53202-0450



EQUIPMENT TYPE: Household and Similar Electric Appliances

EQUIPMENT DESCRIPTION: Commercial Cooking, Holding and Smoking Ovens

MODEL NUMBER: 300, 500, 750, 1000, 1200, 1750,
with suffix TH or SK

APPLIED DIRECTIVES: Low Voltage Directive 2014/35/EC
EMC – 2014/30/EC
RoHS – 2011/65/EU
WEEE – 2012/19/EU

APPLIED STANDARDS: EN 60335-1:2014
EN 60335-2-42:2003 + A1:2008 + A11:2012
EN 55014-1: CISPR 14, EN 55014-2: CISPR 14



We the undersigned, hereby declare that the equipment specified above conforms to the above Directives and Standards

Manufacturer Name:
ALTO-SHAAM INC.
NAME: Christa Pieper
TITLE: Certification Manager

SIGNATURE: 

DATE: October 9th 2020

DECLARATION OF CONFORMITY



ALTO-SHAAM ASIA
Shanghai, China
Phone +86-21-6173 0336

ALTO-SHAAM CANADA
Concord, Ontario Canada
Toll Free Phone 866-577-4484
Phone +1-905-660-6781

**ALTO-SHAAM CENTRAL
& SOUTH AMERICA**
Miami, FL USA
Phone +1-954-655-5727

**ALTO-SHAAM MIDDLE EAST
& AFRICA**
Dubai, UAE
Phone +971 4 321 9712

ALTO-SHAAM MEXICO
Phone +52 1 477-717-3108

ALTO-SHAAM FRANCE, L.L.C.
Aix en Provence, France
Phone +33(0)4-88-78-21-73

ALTO-SHAAM GMBH
Bochum, Germany
Phone +49(0)234-298798-0

ALTO-SHAAM RUSSIA
Moscow, Russia
Phone +7-903-793-2331

ALTO-SHAAM.

Menomonee Falls, WI 53052-0450, U.S.A.
Telephone 800-558-8744 | +1-262-251-3800 | alto-shaam.com